



# HiCAD

UNLIMITED CAD PERFORMANCE DEVELOPED BY ISD

## HiCAD Plant Engineering

Version 2019

Creating new parts and variants

Date of issue: 06/10/2019

[isdgroup.com](http://isdgroup.com)



THE WORLD OF CAD AND PDM SOLUTIONS



# TOC

<b>Creating New Parts and Variants</b> .....	<b>5</b>
<b>Using Connection Type Attributes</b> .....	<b>7</b>
General information .....	7
Connection type ID with priority information .....	8
Connection type ID - List of part standards .....	8
<b>List of Part Type IDs</b> .....	<b>9</b>
Part type IDs in Plant Engineering .....	9
Part type IDs for Air ducts .....	9
<b>Creating Individual Parts: Procedure</b> .....	<b>11</b>
<b>Rules for the Creation of User-Defined Parts</b> .....	<b>13</b>
Part Type: Branch .....	14
Part Type: Valve .....	17
Part Type: Blank Flange .....	20
Part Type: Double Knee .....	22
Part Type: 3-Way Valve .....	24
Part Type: Corner Valve .....	27
Part Type: Flange .....	30
Part Type: Straight Pipe .....	32
Part Type: Y-Piece .....	35
Part Type: Cap .....	38
Part Type: Knee .....	40
Part Type: Cross .....	42
Part Type: Gauge part .....	45
Part Type: Reducer, Concentric .....	47
Part Type: Reducer, Excentric .....	49
Part Type: Elbow .....	51
Part Type: Pipe Clamp .....	53
Part Type: Vessels, Pumps, Other components .....	55
Part Type: Nozzle .....	56
Part Type: Other Pipe Part .....	58
Part Type: T-Piece .....	61
Part Type: 4-Way Valve .....	63
Part Type: Seal .....	66
Pressure ranges .....	67

<b>Part Type: Fastener</b> .....	<b>68</b>
<b>Part Type: Saddle Connection / Elbolet</b> .....	<b>70</b>
<b>Rules for the Creation of User-Defined Feature Variants</b> .....	<b>73</b>
<b>Variant for Part Type: Branch</b> .....	<b>74</b>
<b>Variant for Part Type: Valve</b> .....	<b>77</b>
<b>Variant for Part Type: Blank Flange</b> .....	<b>80</b>
<b>Variant for Part Type: Double Knee</b> .....	<b>82</b>
<b>Variant for Part Type: 3-Way Valve</b> .....	<b>85</b>
<b>Variant for Part Type: Corner Valve</b> .....	<b>88</b>
<b>Variant for Part Type: Flange</b> .....	<b>91</b>
Model welding necks as flanges .....	93
<b>Variant for Part Type: Straight Pipe</b> .....	<b>95</b>
Model collar pieces as straight pipes .....	98
<b>Variant for Part Type: Y-Piece</b> .....	<b>100</b>
<b>Variant for Part Type: Cap</b> .....	<b>103</b>
<b>Variant for Part Type: Knee</b> .....	<b>106</b>
<b>Variant for Part Type: Cross</b> .....	<b>109</b>
<b>Variant for Part Type: Gauge part</b> .....	<b>113</b>
<b>Variant for Part Type: Reducer, Excentric</b> .....	<b>117</b>
<b>Variant for Part Type: Reducer, Concentric</b> .....	<b>120</b>
<b>Variant for Part Type: Elbow</b> .....	<b>123</b>
<b>Variant for Part Type: Pipe Clamp</b> .....	<b>126</b>
<b>Variant for Part Type: Vessels, Pumps, Other Components</b> .....	<b>128</b>
<b>Variant for Part Type: Nozzle</b> .....	<b>130</b>
<b>Variant for Part Type: Other Pipe Parts</b> .....	<b>133</b>
<b>Variant for Part Type: T-Piece</b> .....	<b>138</b>
<b>Variant for Part Type: 4-Way Valve</b> .....	<b>142</b>
<b>Variant for Part Type: Seal</b> .....	<b>145</b>
Pressure ranges .....	146
<b>Variant for Part Type: Fastener</b> .....	<b>148</b>
<b>Variant fpr Part Type: Saddle Connection / Elbolet</b> .....	<b>150</b>
<b>Rules for the Creation of Symbolic Representations</b> .....	<b>153</b>

## Creating New Parts and Variants

Besides using the part and variants which have been predefined by the ISD you can also create,

- new Plant Engineering parts and
- new Feature Variants for Plant Engineering parts.



Please note that for the creation of new parts and new variants certain rules, depending on the particular part type, need to be respected.



**IMPORTANT** - Please note the following when working with user-defined variants for flanges or parts with flanges:

You can use the **Flange connection, bolted** functions of the Plant Engineering module to place boltings on flange connections. To ensure that the boltings match the flanges, the functions will evaluate the variables of the part variant to which the flange belongs. This also needs to be considered if construct your own parts/variants with flange connections, because otherwise, problems will occur during their processing with the flange connection functions.

The following table shows the lists of variables. The second place of the variable's designation must match the connection number. The list here refers to the example of the first connection of a part.

- |            |  |
|------------|--|
| <b>B1</b>  | Thickness of flange plate ( $B1 = C1 + F1$ ) |
| <b>C1</b>  | Thickness of flange plate (without collar)   |
| <b>F1</b>  | Thickness of collar                          |
| <b>A1</b>  | Number of bolts                              |
| <b>K1</b>  | Diameter of bore circle                      |
| <b>D12</b> | Bore diameter                                |
| <b>L</b>   | Part length (not connection-specific)        |

Hence, the variables of the second connection will have the designations B2, C2, F2, A2, D22.

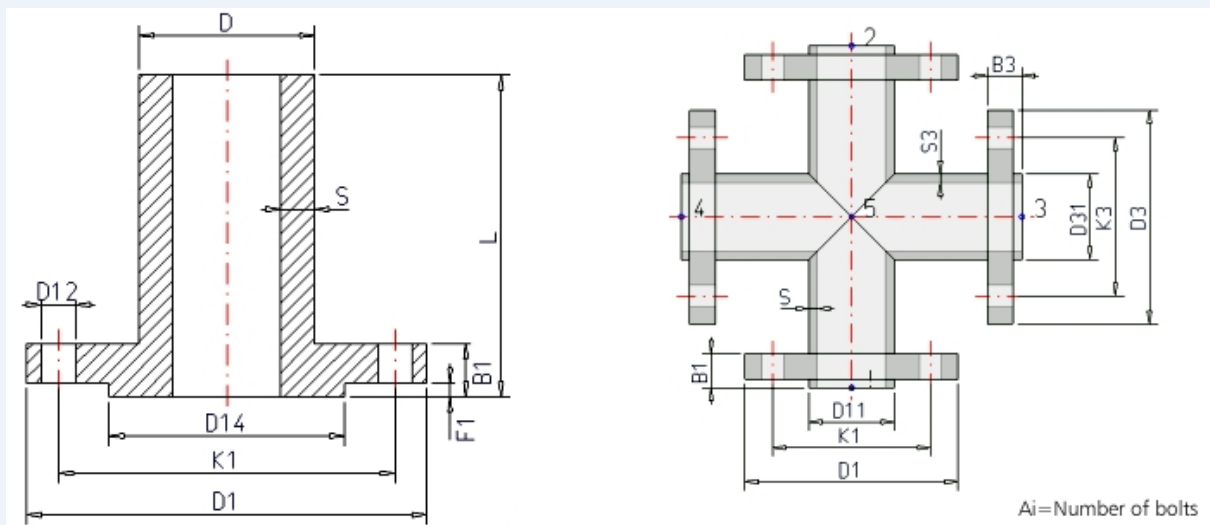

Additional, part-specific rules apply during evaluation:

1. If the variables C1 and F1 are defined in a loose flange, the grip length of the bolting will be determined via the value C1+F1 instead of using B1.
2. For blank flanges the variable L instead of B1 will be used for grip length determination provided that L has been defined.

The value of the variables NI (capital "N", capital "i", NO "1"! ) is used as an additional attribute during creation or querying of an article master in HELiOS. It represents the nominal diameter in Inches

# Using Connection Type Attributes

## General information

In the data records of parts, the attributes

- Anschlussart (=Connection type),
- Anschlussart2 and
- Anschlussart3

enable a determination of the type of connection and of any required accessories. If a part to which particular connecting parts have been assigned via connection attributes is placed onto a guideline, the accessories will be automatically attached to connections 1 and 2 of the part.

If no own attribute entry exists for a connection, the entry with the next lower connection number will be used.

### Example:

If we assume that entries only exist for **Anschlussart** (Connection type) and **Anschlussart3** (Connection type 3) respectively, then the attribute for **Anschluss** (Connection) also applies to connection 2.

The attribute entry is composed of an ID number (connection type ID) and a supplement.

ID	Meaning	ID	Meaning
1000x	welded	3200x	screwed, f
2000x	flange	4100x	plugged, m
2100x	flange with notch	4200x	plugged, f
2200x	flange with groove	5100x	butt-welded, m
3100x	screwed, m	5200x	butt-welded, f

The last digit (x) of the identification number provides additional information on the supplement:

- 0 no supplement
- 2 The supplement is composed of the connection number, part type ID and part standard of the part to be attached.

Example:

**20002 1 5100010 DIN 2633**

This means: "Attach flange according to DIN 2633 with Connection 1."

The wildcard character ('?') is not allowed for the part type ID (in this case 5100010).

The 4th digit of the ID is interpreted as a priority indicator. This digit is important in cases where two parts coincide on one connection which both specify additional parts to be inserted via their connection type (often Fasteners). If one part is connected to another part, on the connecting points of which fasteners are already located, the prioritization will be evaluated.

The meaning of the 3rd digit has not been defined yet.



**Please note:**

- Parts with only one "genuine" connection still require two named isolated points (Designation: ! and 2) to enable them to be auto-aligned correctly. To prevent Point 2 from being falsely interpreted as a connection in the isometry, the attribute ANSCHLUSSART2 needs to be set to the value 0.
- If no entry concerning the "Anschlussart" ("Connection type") attribute exists for a part, HiCAD assumes 10000 (= welded, without supplement).

## Connection type ID with priority information

In practice it can happen that two parts coincide which both specify additional parts to be inserted via their connection type (often Fasteners). In such cases, the last but one digit of the connection will be interpreted as a priority indicator. If one part is connected to another part, on the connecting points of which fasteners are already located, the prioritization will be evaluated. If the part to be connected has a higher priority, the fasteners that already exist on the connection will be removed and replaced with the part to be connected.

If the connection type of the part to be connected has a lower priority, its fasteners will not be inserted.

In cases of equal priority new fasteners will only be inserted if no fasteners exist on the connection yet.

The priority information will also be evaluated if a part does not supply any further elements. Even in such cases, existing fasteners will be removed if the part to be connected has a connection type with a higher priority than that of the existing connection. This means that a part can remove all fasteners because it acts as a fastener itself.

## Connection type ID - List of part standards

Instead of specifying a standard in the supplement, it is also possible to specify a list of standards separated by commas, e.g.

**41002 1 5971010 Standard\_A,Standard\_B,Standard\_C**

During part search in the catalogue or in the HELiOS database the standards will be combined by means of an OR condition. This means that not several parts are specified here, but the range of allowed parts will be extended here.



**Important:**

In the part standards list, spaces will be interpreted as allowed characters of a standard designation. Therefore, no additional spaces must be entered to the right and to the left of the separating commas. Since the standards are separated by commas, they must not contain any commas themselves.



## List of Part Type IDs

In the data record of a part you can, with the help of the so-called connection type attributes, specify the connection types and the fasteners that may be required for this. If a part to which particular fasteners are assigned via connection attributes will be placed on a guideline, these will be automatically placed onto the Connections 1 and 2 of the part.

For this the part type ID will be required.

### Part type IDs in Plant Engineering

ID	Part type	ID	Part type
1000010	Straight pipe	5910011	Double knee
1010011	Nozzle	5920010	Gauge part
2100010	Elbow	5970010	Fastener, symmetrical
2200010	Knee	5971010	Fastener, asymmetrical
3110010	T-piece	5980010	Weld gap
3210011	Y-piece	5990011	Sealing gasket
3230010	Branch	6110010	Saddle connection
3300010	Cross	6110010	Elbolet
4100010	Valve	9100001	Vessel
4200010	Corner valve	9110001	Pump
4300010	3-way valve	5902021	Other parts
4400010	4-way valve	5980010	Sealing gasket
5100010	Flange	9700001	Other component
5210010	Cap	9800001	Gauge
5310010	Reducer, concentric	9960001	Accessory set
5320011	Reducer, excentric	9960001	Bolted flange connection
5710010	Blank flange	9970001	Insulation
5800010	Pipe clamp	9980001	Connection
5900010	Other pipe part		

### Part type IDs for Air ducts

ID	Part type	ID	Part type
1030010	Straight pipe (round)	5610030	Pipe transition, symmetrical (rectangular)
2210020	Elbow, symmetrical (rectangular)	5620031	Pipe transition, asymmetrical (rectangular)

ID	Part type	ID	Part type
2230020	Elbow transition (rectangular)	5510020	Transition, symmetrical (rectangular)
2220020	Angle, symmetrical (rectangular)	5520021	Transition, asymmetrical (rectangular)
2240020	Angle, transition (rectangular)	5530021	Transition fitting (rectangular)
1020020	Duct part (rectangular)	3210021	Y-piece (rectangular)
5410021	Offset bend, symmetrical (rectangular)	3130021	T-piece, with offset (rectangular)
5420021	Offset transition (rectangular)	3120020	T-piece, without offset (rectangular)
5220020	Base (rectangular)	5902021	Other duct parts (rectangular)







## Creating Individual Parts: Procedure

Besides Plant Engineering parts which are based on a variant and are generated via this variant, you can also create new, individual parts with fixed dimensions. If you want to construct a new, non- parameterised (fixed) Plant Engineering part for the available representation types, proceed as follows:







Please observe the Rules for the creation of the respective part type, as well as the Rules for the creation of symbolic representations.

**With the HELiOS Database as part data source:** (3 representation types are possible)

1. Construct a hollow body in HiCAD 3-D.
2. Save part as KRA file (without referencing, without part master and document master) to *PlantParts\Parts2*.
3. Check part with the **Check part, Geometry**  function.
4. Construct a solid body in HiCAD 3-D.
5. Save part as KRA file (without referencing, without part master and document master) to *PlantParts\Parts3*, with the same name as the hollow body representation.
6. Check part with the **Check part, Geometry**  function.
7. Load the new KRA file from *PlantParts\Parts3* with the **PAA-Editor**  and modify it as desired (enter attribute values). Save the part, i.e. create a PAA file.
8. Activate the **Part data synchronisation**  function to perform the part data synchronisation with the database.
9. Check the attribute data with the **Check parts, Attributes**  function.
10. Create the symbolic representation with the **Symbol Editor**  and add it to the new PAA file.

**With the HiCAD Catalogue as part data source:** (2 representation types are possible)



1. Construct a hollow body in HiCAD 3-D.
2. Save part as KRA file („Save as part“, without referencing) to *PlantParts\Parts2*.
3. Check part with the **Check part, Geometry**  function.
4. Construct a solid body in HiCAD 3-D.
5. Save part as KRA file („Save as part“, without referencing) to *PlantParts\Parts3*, with the same name as the hollow body representation.
6. Check part with the **Check part, Geometry**  function.
7. Load the new KRA file from *PlantParts\Parts3* with the **PAA-Editor**  and modify it as desired (enter attribute values). Save the part, i.e. create a PAA file.

8. Activate the **Part data synchronisation**  function to perform the part data synchronisation (this function calls the **VarToCat** tool).

If you want to initially create only one representation type for a Plant Engineering part in order to check whether the part functions in the way you expect it, you can omit three steps in the procedures described above:

- If you initially only require the solid body representation, omit the steps 1 - 3.
- If you initially only require the hollow body representation, omit the steps 4 - 6. Continue with step 7 to load the KRA file from *PlantParts\Parts2*.

If you want to add another representation type later (here: hollow body), the following steps are required:

1. Construct a hollow body in HiCAD 3-D.
2. Save part as KRA file („Save as part“, without referencing) to *PlantParts\Parts2* with a different name than the other representation type.
3. Check part with the **Check part, Geometry**  function
4. Load the new KRA file from *PlantParts\Parts2* with the **PAA-Editor** . Do not modify it, but save it immediately, i.e. create a PAA file. (If you have created the solid body representation instead of the hollow body representation, load the new KRA file from *PlantParts\Parts3*).
5. Now load the PAA file of the representation type that you have first created and tested (here: Solid body) from *PlantParts* with the **PAA Editor** . Use the **Edit archive** option to add the second representation type (here: Hollow body) from the corresponding PAA file. In the PAA Editor, save the - still open - PAA file of the first representation type, whereupon it will contain both representation types. The PAA file of the second representation type is now no longer needed.

Another part data synchronisation will not be required if you have only added the second representation type.

## Rules for the Creation of User-Defined Parts



Besides Plant Engineering parts which are based on and created via a variant, you can also create new, individual parts with fixed dimensions. These parts are .PAA files. For their creation certain rules, depending on the particular part type, need to be respected.

When using your own variants for flanges or parts with flanges, please read the notes on bolted flange connections!

- Part type: Branch
- Part type: Valve
- Part type: Blank flange
- Part type: Double knee
- Part type: 3-way valve
- Part type: Corner valve
- Part type: Flange
- Part type: Straight pipe
- Part type: Y-piece
- Part type: Cap
- Part type: Knee
- Part type: Cross
- Part type: Gauge part
- Part type: Reducer, concentric
- Part type: Reducer, excentric
- Part type: Elbow
- Part type: Pipe clamp
- Part type: Vessels, Pumps, Other components
- Part type: Nozzles
- Part type: Other pipe part
- Part type: T-piece
- Part type: 4-way valve
- Part type: Seal
- Part type: Fasteners
- Part type: Saddle connection / Elbolet

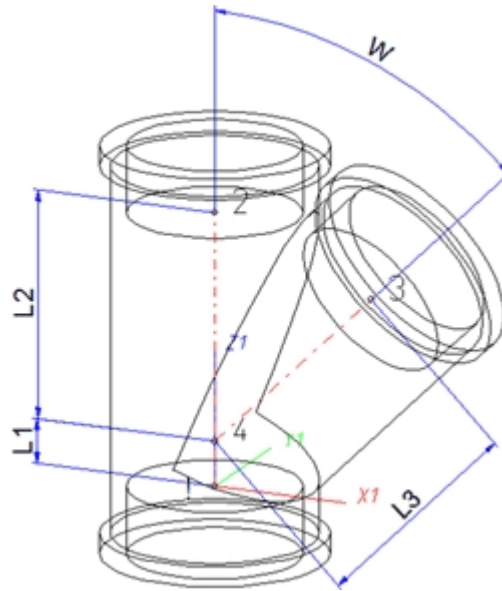
## Part Type: Branch

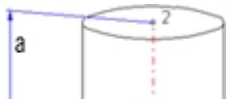
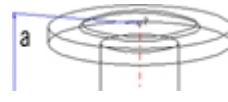

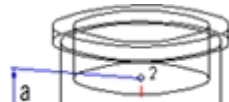
Position of connecting points and determination of insertion lengths for various connection types			
Connection for butt welding	Flange connection	Connecting nipple for screwed, plugged or socket-welded connection	Connecting socket for screwed, plugged or socket-welded connection
			
a = Insertion length dimension (e.g. L, L1 etc.)	a = Insertion length dimension (e.g. L, L1 etc.)	a = Insertion length dimension (e.g. L, L1 etc.)	a = Insertion length dimension (e.g. L, L1 etc.)

### Named isolated points

Designation	Purpose	Comment	Position in coordinate system
!	Connecting point	Fitting point	in origin (0,0,0)
2	Connecting point		$X = 0, Y = 0, Z > 0$
3	Connecting point	on branch	$X > 0, Y = 0, Z > 0$
4	Auxiliary point	Branching point of centre line	$X = 0, Y = 0, Z > 0$

### Required attributes for entries into database or catalogue

The entering of attribute values and the part type selection should be performed using the PAA Editor.

Values need to be entered for at least the following attributes:

Attribute	Description
BENENNUNG	Designation of part
NORMBEZEICHNUNG	Standard designation of the part. An entry is mandatory, even if the part corresponds to no standard.
WINKEL	Angle (see angle in drawing)
NENNWEITE	Nominal diameter , Connection "1"
NENNWEITE2	Nominal diameter, Connection "2"
NENNWEITE3	Nominal diameter, Connection "3"
<b>Additionally (only if the corresponding standard uses nominal diameters in inches):</b>	
NPS_INCH	Nominal diameter (inches) (e.g. 1 1/2", the " consists of two " characters), Connection "1"
NPS2_INCH	Nominal diameter (inches), Connection "2"
NPS3_INCH	Nominal diameter (inches), Connection "3"
<b>These parameters are to be considered for all connection types except for flange connections. For connecting sockets they refer to the pipe to be inserted:</b>	
D_AUSSEN	Outer diameter, Connection "1"
D2_AUSSEN	Outer diameter, Connection "2"
D3_AUSSEN	Outer diameter, Connection "3"
WANDDICKE	Wall thickness, Connection "1"
WANDDICKE2	Wall thickness, Connection "2"
WANDDICKE3	Wall thickness, Connection "3"
ANSCHLUSSART	Connection type , Connection "1"
ANSCHLUSSART2	Connection type , Connection "2"
ANSCHLUSSART3	Connection type, Connection "3"
Possible values of the attribute ANSCHLUSSART (CONNECTION_TYPE):	

Attribute	Description
1000x	Butt-welded
2000x	Flange connection
2100x	Flange with groove connection
2200x	Flange with notch connection
2040x	<p>Flange connection of a part that is not a flange itself. The part has a loose flange that is modelled as a sub-part and has no own article master attached to this connection.</p>
3100x	Screwed, nipple
3200x	Screwed, socket
4100x	Plugged, nipple
4200x	Plugged, socket
5100x	Socket-welded, nipple
5200x	Socket-welded, socket
<p>The last character (x) provides information about the meaning of the supplement:</p>	
<p><b>0</b>=No supplement</p>	
<p><b>2</b>= The supplement consists of connection number, part type, ID, and standard of the part to be connected</p>	
<p>The prefixed connection number indicates the connection with which the auxiliary part is to be attached to the current connection.</p>	
<p> Please also read the information given in the paragraphs Connection type ID with priority information and Connection type ID - List of part standards.</p>	



## Part Type: Valve

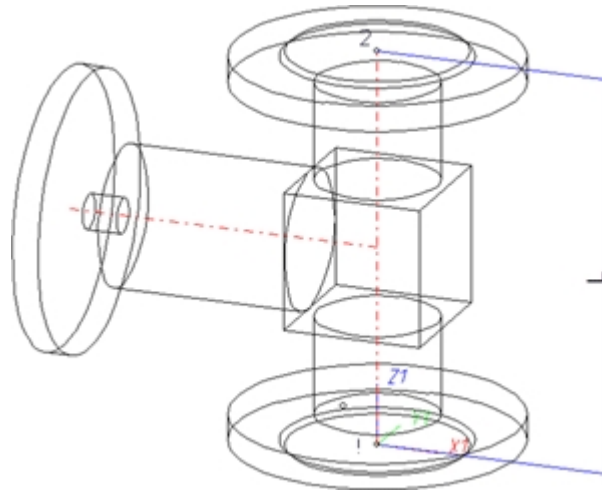

The centre axis of the actuator should be located in the plane  $X < 0, Y = 0, Z > 0!$

Position of connecting points and determination of insertion lengths for various connection types			
Connection for butt welding	Flange connection	Connecting nipple for screwed, plugged or socket-welded connection	Connecting socket for screwed, plugged or socket-welded connection
a = Insertion length dimension (e.g. L, L1 etc.)	a = Insertion length dimension (e.g. L, L1 etc.)	a = Insertion length dimension (e.g. L, L1 etc.)	a = Insertion length dimension (e.g. L, L1 etc.)

### Named isolated points

Designation	Purpose	Comment	Position in coordinate system
!	Connecting point	Fitting point	in origin (0,0,0)
2	Connecting point		$X = 0, Y = 0, Z > 0$

### Required attributes for entries into database or catalogue

The entering of attribute values and the part type selection should be performed using the PAA Editor.

Values need to be entered for at least the following attributes:

Attribute	Description
BENENNUNG	Designation of part
NORMBEZEICHNUNG	Standard designation of the part. An entry is mandatory, even if the part corresponds to no standard.

Attribute	Description
NENNWEITE	Nominal diameter, Connection “1” and “2”
<b>Additionally (only if the corresponding standard uses nominal diameters in inches):</b>	
NPS_INCH	Nominal diameter (inches) (e.g. 1 1/2", the " consists of two " characters), Connection “1” and “2”
<b>These parameters are to be considered for all connection types except for flange connections. For connecting sockets they refer to the pipe to be inserted:</b>	
D_AUSSEN	Outer diameter, Connection “1” and “2”
WANDDICKE	Wall thickness, Connection “1” and “2”
ANSCHLUSSART	Connection type
Possible values of the attribute ANSCHLUSSART (CONNECTION_TYPE):	
1000x	Butt-welded
2000x	Flange connection
2100x	Flange with groove connection
2200x	Flange with notch connection
2040x	Flange connection of a part that is not a flange itself. The part has a loose flange that is modelled as a sub-part and has no own part master attached to this connection.
3100x	Screwed, nipple
3200x	Screwed, socket
4100x	Plugged, nipple
4200x	Plugged, socket
5100x	Socket-welded, nipple
5200x	Socket-welded, socket
<p><b>Provide auxiliary part when fitting part</b></p> <p>If appropriately preset in the ANSCHLUSSART (CONNECTION_TYPE) attribute for a connection, the part will provide and connect an auxiliary part of the standard specified in the attribute for the connection when being fitted. For example, if the part has a flange connection and the corresponding counter-flange is required, the content of the ANSCHLUSSART (CONNECTION_TYPE) attribute could look as follows:  <b>20002 1 5100010 EN 1092-1/11/A/PN 40</b>  <b>EN 1092-1/11/A/PN 40</b> is the standard designation with which the flange is to be entered into the database.</p>	
<p>The last character (x) provides information about the meaning of the supplement:  <b>0</b>=No supplement  <b>2</b>= The supplement consists of connection number, part type, ID, and standard of the part to be connected                      The prefixed connection number indicates the connection with which the auxiliary part is to be attached to the current connection.</p>	
 Please also read the information given in the paragraphs Connection type ID with priority information and Connection type ID - List of part standards.	

Connection types: Examples

EN10253-4-A\_TEE\_RED

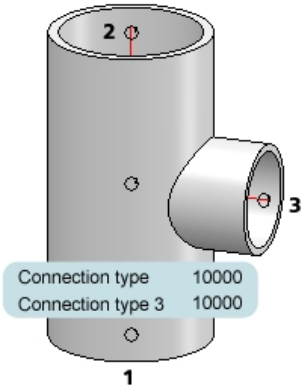

GF\_211501\_W\_45

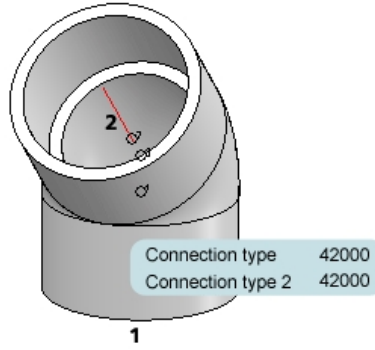

GF\_239105\_SLEEVE\_NIPPLE\_M\_R

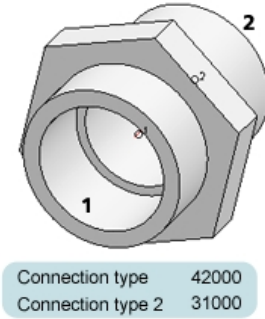

GF\_300000043\_052\_PIPE

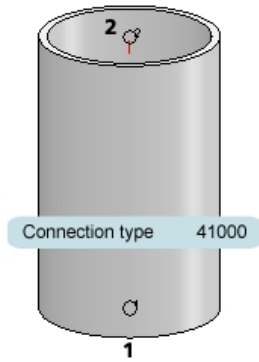

ERMETO\_O\_WE\_M\_S

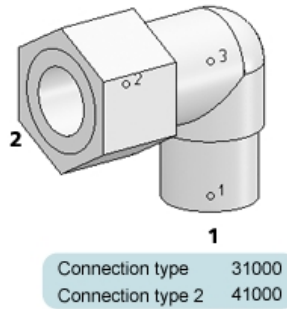

JACOB\_WELDED\_PIPE

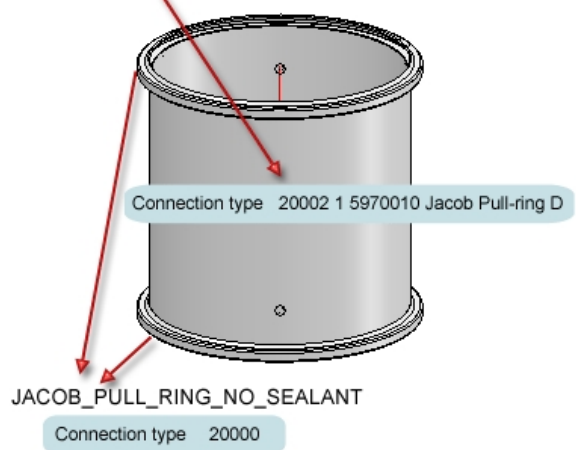

Parts with socket-welded connections (51000 / 52000) are currently not contained in the HiCAD part inventory.

## Part Type: Blank Flange

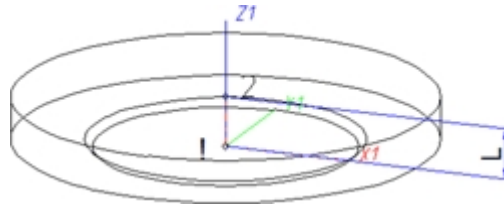

### Named isolated points

Designation	Purpose	Comment	Position in coordinate system
!	Connecting point	Fitting point	in origin (0,0,0)
2	Auxiliary point		X = 0, Y = 0, Z > 0

### Required attributes for entries into database or catalogue

The entering of attribute values and the part type selection should be performed using the PAA Editor.

Values need to be entered for at least the following attributes:

Attribute	Description
BENENNUNG	Designation of part
NORMBEZEICHNUNG	Standard designation of the part. An entry is mandatory, even if the part corresponds to no standard.
NENNWEITE	Nominal diameter, Connection "!"
<b>Additionally (only if the corresponding standard uses nominal diameters in inches):</b>	
NPS_INCH	Nominal diameter (inches) (e.g. 1 1/2", the " consists of two " characters), Connection "!"
ANSCHLUSSART	Connection type for Connection "!" (always flange connection)
Possible values of the attribute ANSCHLUSSART (CONNECTION_TYPE):	

Attribute	Description
1000x	Butt-welded
2000x	Flange connection
2100x	Flange with groove connection
2200x	Flange with notch connection
3100x	Screwed, nipple
3200x	Screwed, socket
4100x	Plugged, nipple
4200x	Plugged, socket
5100x	Socket-welded, nipple
5200x	Socket-welded, socket
<p>The last character (x) provides information about the meaning of the supplement:  <b>0</b>=No supplement  <b>2</b>= The supplement consists of connection number, part type, ID, and standard of the part to be connected                      The prefixed connection number indicates the connection with which the auxiliary part is to be attached to the current connection.</p>	
<p> Please also read the information given in the paragraphs Connection type ID with priority information and Connection type ID - List of part standards.</p>	

## Part Type: Double Knee

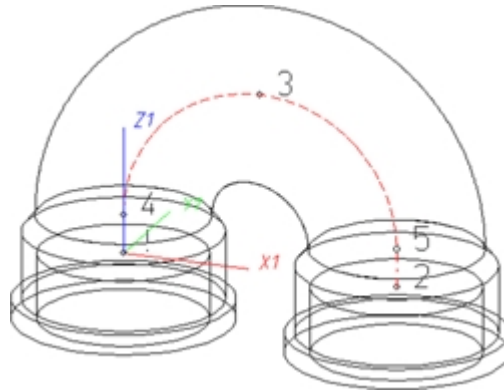

### Named isolated points

Designation	Purpose	Comment	Position in coordinate system
!	Connecting point	Fitting point	in origin (X1=0, Y1=0, Z1=0)
2	Connecting point		X2 > 0, Y2 = 0, Z2 = 0
3	Auxiliary point		X3 = X2/2, Y3 = 0, Z3 > Z4
4	Auxiliary point		X4 = 0, Y4 = 0, Z4 > 0
5	Auxiliary point		X5 = X2, Y5 = 0, Z5 = Z4

### Required attributes for entries into database or catalogue

The entering of attribute values and the part type selection should be performed using the PAA Editor.

Values need to be entered for at least the following attributes:

Attribute	Description
BENENNUNG	Designation of part
NORMBEZEICHNUNG	Standard designation of the part. An entry is mandatory, even if the part corresponds to no standard.
NENNWEITE	Nominal diameter, Connection "!" and "2"
<b>Additionally (only if the corresponding standard uses nominal diameters in inches):</b>	
NPS_INCH	Nominal diameter (inches) (e.g. 1 1/2", the " consists of two " characters), Connection "!" and "2"
<b>These parameters are to be considered for all connection types except for flange connections. For connecting sockets they refer to the pipe to be inserted:</b>	
D_AUSSEN	Outer diameter, Connection "!" and "2"

Attribute	Description
WANDDICKE	Wall thickness, Connection "1" and "2"
ANSCHLUSSART	Connection type , Connection "1"
ANSCHLUSSART2	Connection type, Connection "2"

Possible values of the attribute ANSCHLUSSART (CONNECTION\_TYPE):.

- 1000x Butt-welded
- 2000x Flange connection
- 2100x Flange with groove connection
- 2200x Flange with notch connection
- 2040x Flange connection of a part that is not a flange itself. The part has a loose flange that is modelled as a sub-part and has no own article master attached to this connection.
- 3100x Screwed, nipple
- 3200x Screwed, socket
- 4100x Plugged, nipple
- 4200x Plugged, socket
- 5100x Socket-welded, nipple
- 5200x Socket-welded, socket

**Provide auxiliary part when fitting part**

If appropriately preset in the ANSCHLUSSART (CONNECTION\_TYPE) attribute for a connection, the part will provide and connect an auxiliary part of the standard specified in the attribute for the connection when being fitted. For example, if the part has a flange connection and the corresponding counter-flange is required, the content of the ANSCHLUSSART (CONNECTION\_TYPE) attribute could look as follows:

**20002 1 5100010 EN 1092-1/11/A/PN 40**

**EN 1092-1/11/A/PN 40** is the standard designation with which the flange is to be entered into the database.

The last character (x) provides information about the meaning of the supplement:

**0**=No supplement

**2**= The supplement consists of connection number, part type, ID, and standard of the part to be connected

The prefixed connection number indicates the connection with which the auxiliary part is to be attached to the current connection.



Please also read the information given in the paragraphs Connection type ID with priority information and Connection type ID - List of part standards.

### Part Type: 3-Way Valve

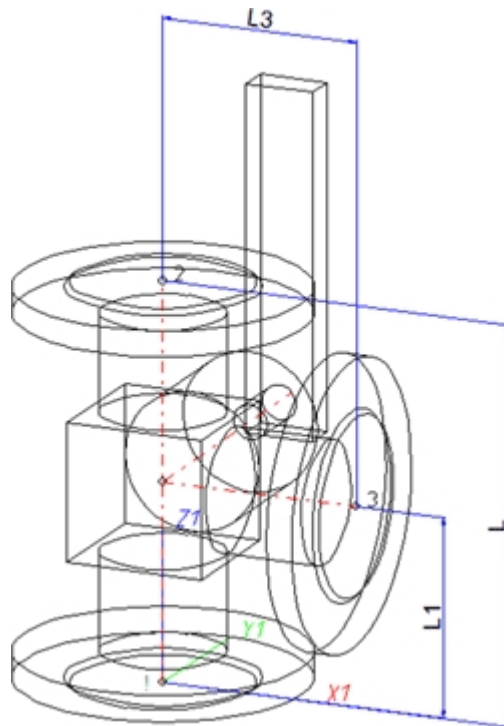

Position of connecting points and determination of insertion lengths for various connection types			
Connection for butt welding	Flange connection	Connecting nipple for screwed, plugged or socket-welded connection	Connecting socket for screwed, plugged or socket-welded connection
a = Insertion length dimension (e.g. L, L1 etc.)	a = Insertion length dimension (e.g. L, L1 etc.)	a = Insertion length dimension (e.g. L, L1 etc.)	a = Insertion length dimension (e.g. L, L1 etc.)

#### Named isolated points

Designation	Purpose	Comment	Position in coordinate system
!	Connecting point	Fitting point	in origin (0,0,0)
2	Connecting point		X = 0, Y = 0, Z > 0
3	Connecting point	on branch	X > 0, Y = 0, Z > 0

#### Required attributes for entries into database or catalogue

The entering of attribute values and the part type selection should be performed using the PAA Editor.

Values need to be entered for at least the following attributes:



Attribute	Description
BENENNUNG	Designation of part
NORMBEZEICHNUNG	Standard designation of the part. An entry is mandatory, even if the part corresponds to no standard.
NENNWEITE	Nominal diameter, Connection “1” and “2”
NENNWEITE3	Nominal diameter, Connection “3”
<b>Additionally (only if the corresponding standard uses nominal diameters in inches):</b>	
NPS_INCH	Nominal diameter (inches) (e.g. 1 1/2", the " consists of two " characters) , Connection “1” and “2”
NPS3_INCH	Nominal diameter (inches), Connection “3”
<b>These parameters are to be considered for all connection types except for flange connections. For connecting sockets they refer to the pipe to be inserted:</b>	
D_AUSSEN	Outer diameter, Connection “1” and “2”
D3_AUSSEN	Outer diameter, Connection “3”
WANDDICKE	Wall thickness, Connection “1” and “2”
WANDDICKE3	Wall thickness, Connection “3”
ANSCHLUSSART	Connection type, Connection “1”, “2” and “3”
<b>Possible values of the attribute ANSCHLUSSART (CONNECTION_TYPE):</b>	
1000x	Butt-welded
2000x	Flange connection
2100x	Flange with groove connection
2200x	Flange with notch connection
2040x	Flange connection of a part that is not a flange itself. The part has a loose flange that is modelled as a sub-part and has no own article master attached to this connection.
3100x	Screwed, nipple
3200x	Screwed, socket
4100x	Plugged, nipple
4200x	Plugged, socket
5100x	Socket-welded, nipple
5200x	Socket-welded, socket
<p>The last character (x) provides information about the meaning of the supplement:  <b>0</b>=No supplement  <b>2</b>= The supplement consists of connection number, part type, ID, and standard of the part to be connected                      The prefixed connection number indicates the connection with which the auxiliary part is to be attached to the current connection.</p>	

Attribute	Description
	Please also read the information given in the paragraphs Connection type ID with priority information and Connection type ID - List of part standards.

### Part Type: Corner Valve

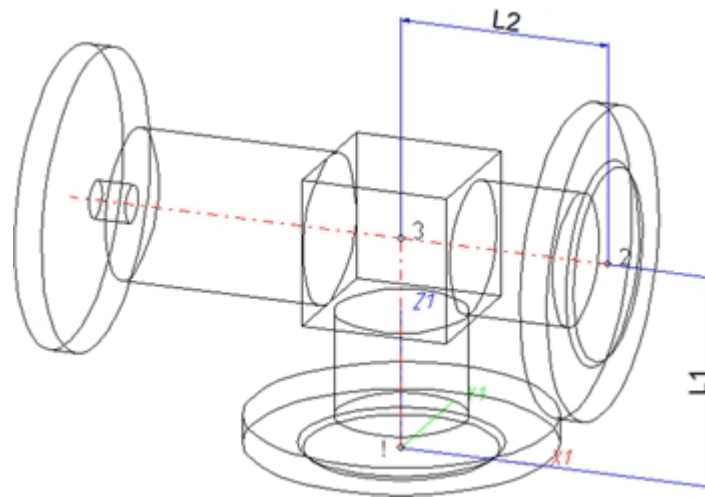

Position of connecting points and determination of insertion lengths for various connection types			
Connection for butt welding	Flange connection	Connecting nipple for screwed, plugged or socket-welded connection	Connecting socket for screwed, plugged or socket-welded connection
a = Insertion length dimension (e.g. L, L1 etc.)	a = Insertion length dimension (e.g. L, L1 etc.)	a = Insertion length dimension (e.g. L, L1 etc.)	a = Insertion length dimension (e.g. L, L1 etc.)

### Named isolated points

Designation	Purpose	Comment	Position in coordinate system
!	Connecting point	Fitting point	in origin (0,0,0)
2	Connecting point		$X > 0, Y = 0, Z > 0$
3	Corner point		$X = 0, Y = 0, Z > 0$

### Required attributes for entries into database or catalogue

The entering of attribute values and the part type selection should be performed using the PAA Editor.

Values need to be entered for at least the following attributes:

Attribute	Description
BENENNUNG	Designation of part
NORMBEZEICHNUNG	Standard designation of the part. An entry is mandatory, even if the part corresponds to no standard.



Attribute	Description
NENNWEITE	Nominal diameter, Connection “1”
NENNWEITE2	Nominal diameter, Connection “2”
<b>Additionally (only if the corresponding standard uses nominal diameters in inches):</b>	
NPS_INCH	Nominal diameter (inches) (e.g. 1 1/2“, the " consists of two " characters), Connection“1”
NPS2_INCH	Nominal diameter (inches), Connection “2”
<b>These parameters are to be considered for all connection types except for flange connections. For connecting sockets they refer to the pipe to be inserted:</b>	
D_AUSSEN	Outer diameter , Connection “1”
D2_AUSSEN	Outer diameter, Connection “2”
WANDDICKE	Wall thickness, Connection “1”
WANDDICKE2	Wall thickness, Connection “2”
ANSCHLUSSART	Connection type, Connection “1” and “2”
Possible values of the attribute ANSCHLUSSART (CONNECTION_TYPE):.	
1000x	Butt-welded
2000x	Flange connection
2100x	Flange with groove connection
2200x	Flange with notch connection
2040x	Flange connection of a part that is not a flange itself. The part has a loose flange that is modelled as a sub-part and has no own article master attached to this connection.
3100x	Screwed, nipple
3200x	Screwed, socket
4100x	Plugged, nipple
4200x	Plugged, socket
5100x	Socket-welded, nipple
5200x	Socket-welded, socket
<p>The last character (x) provides information about the meaning of the supplement:  <b>0</b>=No supplement  <b>2</b> = The supplement consists of connection number, part type, ID, and standard of the part to be connected                      The prefixed connection number indicates the connection with which the auxiliary part is to be attached to the current connection.</p>	
<p> Please also read the information given in the paragraphs Connection type ID with priority information and Connection type ID - List of part standards.</p>	

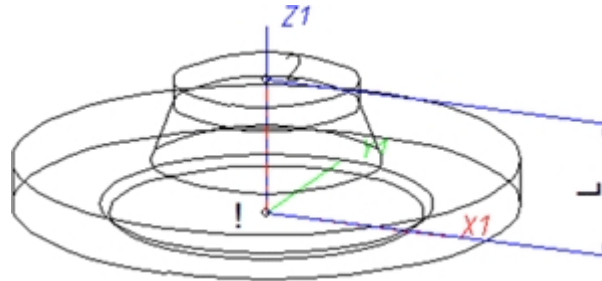

When using the HELIOS database, please make sure that you use the correct Classification matching the part type!

## Part Type: Flange

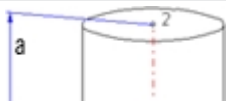
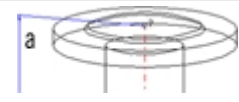

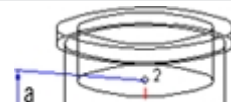
Position of connecting points and determination of insertion lengths for various connection types			
Connection for butt welding	Flange connection	Connecting nipple for screwed, plugged or socket-welded connection	Connecting socket for screwed, plugged or socket-welded connection
			
a = Insertion length dimension (e.g. L, L1 etc.)	a = Insertion length dimension (e.g. L, L1 etc.)	a = Insertion length dimension (e.g. L, L1 etc.)	a = Insertion length dimension (e.g. L, L1 etc.)

### Named isolated points

Designation	Purpose	Comment	Position in coordinate system
!	Connecting point	Fitting point	in origin (0,0,0)
2	Connecting point		X = 0, Y = 0, Z > 0

### Required attributes for entries into database or catalogue

The entering of attribute values and the part type selection should be performed using the PAA Editor.

Values need to be entered for at least the following attributes:



Attribute	Description
BENENNUNG	Designation of part
NORMBEZEICHNUNG	Standard designation of the part. An entry is mandatory, even if the part corresponds to no standard.
NENNWEITE	Nominal diameter, Connection "!" and "2"
<b>Additionally (only if the corresponding standard uses nominal diameters in inches):</b>	
NPS_INCH	Nominal diameter (inches) (e.g. 1 1/2", the " consists of two " characters), Connection "!" and "2"

Attribute	Description
D_AUSSEN	Outer diameter, Connection "2"
WANDDICKE	Wall thickness, Connection "2"
ANSCHLUSSART	Connection type , Connection"! " (always flange connection)
ANSCHLUSSART2	Connection type, Connection"2"
Possible values of the attribute ANSCHLUSSART (CONNECTION_TYPE):	
1000x	Butt-welded
2000x	Flange connection
2100x	Flange with groove connection
2200x	Flange with notch connection
2010x	Flange connection of a loose flange
3100x	Screwed, nipple
3200x	Screwed, socket
4100x	Plugged, nipple
4200x	Plugged, socket
5100x	Socket-welded, nipple
5200x	Socket-welded, socket
<p>The last character (x) provides information about the meaning of the supplement:  <b>0</b>=No supplement  <b>2</b>= The supplement consists of connection number, part type, ID, and standard of the part to be connected                      The prefixed connection number indicates the connection with which the auxiliary part is to be attached to the current connection.</p> <p><b>Provide auxiliary part when fitting part</b>                      If appropriately preset in the ANSCHLUSSART (CONNECTION_TYPE) attribute for a connection, the part will provide and connect an auxiliary part of the standard specified in the attribute for the connection when being fitted. For example, if the part has a flange connection and the corresponding counter-flange is required, the content of the ANSCHLUSSART (CONNECTION_TYPE) attribute could look as follows:  <b>20002 1 5100010 EN 1092-1/11/A/PN 40</b>  <b>EN 1092-1/11/A/PN 40</b> is the standard designation with which the flange is to be entered into the database.</p>	
<p> Please also read the information given in the paragraphs Connection type ID with priority information and Connection type ID - List of part standards.</p>	

 **Loose flanges** are assigned to the part type **Flange**. The attribute ANSCHLUSSART (=CONNECTION\_TYPE), however, must have the value 20100!

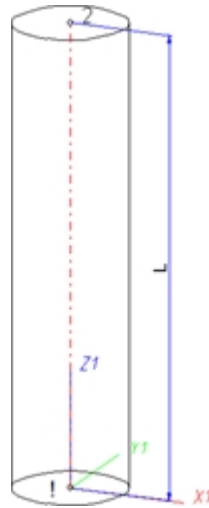
## Part Type: Straight Pipe

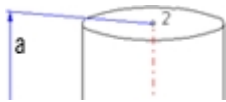
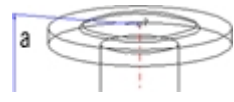
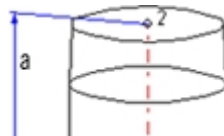

Position of connecting points and determination of insertion lengths for various connection types			
Connection for butt welding	Flange connection	Connecting nipple for screwed, plugged or socket-welded connection	Connecting socket for screwed, plugged or socket-welded connection
			
a = Insertion length dimension (e.g. L, L1 etc.)	a = Insertion length dimension (e.g. L, L1 etc.)	a = Insertion length dimension (e.g. L, L1 etc.)	a = Insertion length dimension (e.g. L, L1 etc.)

### Named isolated points

Designation	Purpose	Comment	Position in coordinate system
!	Connecting point	Fitting point	in origin (0,0,0)
2	Connecting point		X = 0, Y = 0, Z > 0

### Required attributes for entries into database or catalogue

The entering of attribute values and the part type selection should be performed using the PAA Editor.

Values need to be entered for at least the following attributes:

Attribute	Designation
BENENNUNG	Designation of part
NORMBEZEICHNUNG	Standard designation of the part. An entry is mandatory, even if the part corresponds to no standard.
BELIEBIG_TEILBAR	Indicates whether a cutting to length of the pipe is permissible



Attribute	Designation
LIEFERLAENGE	Supplied length in m (!)
NENNWEITE	Nominal diameter, Connection "1" and "2"
<b>Additionally (only if the corresponding standard uses nominal diameters in inches):</b>	
NPS_INCH	Nominal diameter (inches) (e.g. 1 1/2", the " consists of two " characters), Connection "1" and "2"
<b>These parameters are to be considered for all connection types except for flange connections. For connecting sockets they refer to the pipe to be inserted:</b>	
D_AUSSEN	Outer diameter, Connection "1" and "2"
WANDDICKE	Wall thickness, Connection "1" and "2"
ANSCHLUSSART  ANSCHLUSSART2	<p>Connection type , Connection "1" (and "2")</p> <p>If you want both pipe ends to have the same connection type it will suffice to specify a value for the ANSCHLUSSART attribute.</p> <p>If you want the two pipe ends to have different connection types, the connection type for Connection 1 must be specified for the ANSCHLUSSART attribute, and the connection type for Connection 2 for the ANSCHLUSSART2 attribute.</p> <p>If you want to create a new feature variant of a straight pipe with different connection types, the part must be constructed in such a way that the value of the attribute ANSCHLUSSART is smaller than the value of the attribute ANSCHLUSSART2.</p> <p><b>Example:</b></p> <p>Let us assume that you require a pipe that can be butt-welded at one end, and has a screwed socket at the other end.</p> <p>The connection type for butt-welded connections is 10000, the one for screwed sockets is 32000. This means that Connection 1 (Point designation "1") is required for the welded connection (ANSCHLUSSART = 10000) and Connection 2 (point designation "2") is required for the screwed connection (ANSCHLUSSART2 = 32000).</p>
Possible values of the attribute ANSCHLUSSART (CONNECTION_TYPE):	

Attribute	Designation
1000x	Butt-welded
2000x	Flange connection
2100x	Flange with groove connection
2200x	Flange with notch connection
2040x	Flange connection of a part that is not a flange itself. The part has a loose flange that is modelled as a sub-part and has no own article master attached to this connection.
3100x	Screwed, nipple
3200x	Screwed, socket
4100x	Plugged, nipple
4200x	Plugged, socket
5100x	Socket-welded, nipple
5200x	Socket-welded, socket
The last character (x) provides information about the meaning of the supplement:	
<b>0</b> =No supplement	
<b>2</b> = The supplement consists of connection number, part type, ID, and standard of the part to be connected	
The prefixed connection number indicates the connection with which the auxiliary part is to be attached to the current connection.	
	
Please also read the information given in the paragraphs Connection type ID with priority information and Connection type ID - List of part standards.	

### Part Type: Y-Piece

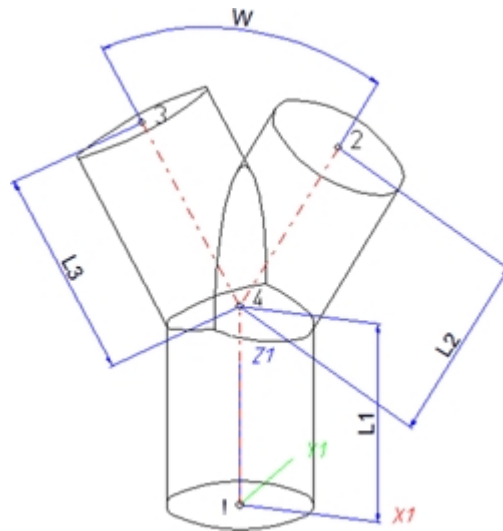

Position of connecting points and determination of insertion lengths for various connection types			
Connection for butt welding	Flange connection	Connecting nipple for screwed, plugged or socket-welded connection	Connecting socket for screwed, plugged or socket-welded connection
a = Insertion length dimension (e.g. L, L1 etc.)	a = Insertion length dimension (e.g. L, L1 etc.)	a = Insertion length dimension (e.g. L, L1 etc.)	a = Insertion length dimension (e.g. L, L1 etc.)

### Named isolated points

Designation	Purpose	Comment	Position in coordinate system
!	Connecting point	Fitting point	in origin (0,0,0)
2	Connecting point		$X > 0, Y = 0, Z > 0$
3	Connecting point		$X < 0, Y = 0, Z > 0$
4	Auxiliary point		$X = 0, Y = 0, Z > 0$

### Required attributes for entries into database or catalogue

The entering of attribute values and the part type selection should be performed using the PAA Editor.

Values need to be entered for at least the following attributes:

Attribute	Description
BENENNUNG	Designation of part
NORMBEZEICHNUNG	Standard designation of the part.

Attribute	Description
	An entry is mandatory, even if the part corresponds to no standard.
NENNWEITE	Nominal diameter, Connection “!”
NENNWEITE2	Nominal diameter, Connection “2” and “3”
<b>Additionally (only if the corresponding standard uses nominal diameters in inches):</b>	
NPS_INCH	Nominal diameter (inches) (e.g. 1 1/2“, the " consists of two " characters), Connection“!”
NPS2_INCH	Nominal diameter (inches), Connection“2” and “3”
<b>These parameters are to be considered for all connection types except for flange connections. For connecting sockets they refer to the pipe to be inserted:</b>	
D_AUSSEN	Outer diameter, Connection“!”
D2_AUSSEN	Outer diameter, Connection“2” and “3”
WANDDICKE	Wall thickness, Connection“!”
WANDDICKE2	Wall thickness, Connection“2” and “3”
ANSCHLUSSART	Connection type, Connection“!”
ANSCHLUSSART2	Connection type, Connection“2” and “3”
Possible values of the attribute ANSCHLUSSART (CONNECTION_TYPE):	
1000x	Butt-welded
2000x	Flange connection
2100x	Flange with groove connection
2200x	Flange with notch connection
2040x	Flange connection of a part that is not a flange itself. The part has a loose flange that is modelled as a sub-part and has no own article master attached to this connection.
3100x	Screwed, nipple
3200x	Screwed, socket
4100x	Plugged, nipple
4200x	Plugged, socket
5100x	Socket-welded, nipple
5200x	Socket-welded, socket
<p><b>Provide auxiliary part when fitting part</b>                      If appropriately preset in the ANSCHLUSSART (CONNECTION_TYPE) attribute for a connection, the part will provide and connect an auxiliary part of the standard specified in the attribute for the connection when being fitted. For example, if the part has a flange connection and the corresponding counter-flange is required, the content of the ANSCHLUSSART (CONNECTION_TYPE) attribute could look as follows:  <b>20002 1 5100010 EN 1092-1/11/A/PN 40</b>  <b>EN 1092-1/11/A/PN 40</b> is the standard designation with which the flange is to be entered into the database.</p>	
<p>The last character (x) provides information about the meaning of the supplement:  <b>0</b> = No supplement  <b>2</b> = The supplement consists of connection number, part type, ID, and standard of the part to be connected                      The prefixed connection number indicates the connection with which the auxiliary part is to be attached to the current connection.</p>	

Attribute	Description
	Please also read the information given in the paragraphs Connection type ID with priority information and Connection type ID - List of part standards.

## Part Type: Cap

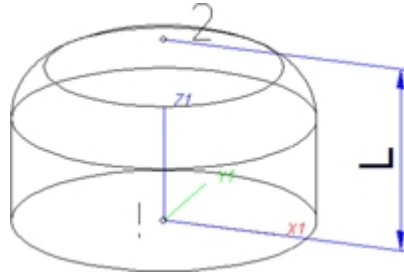

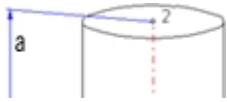
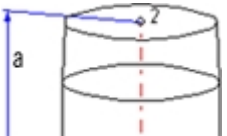
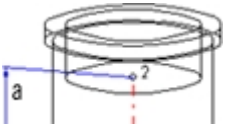
Position of connecting points and determination of insertion lengths for various connection types		
Connection for butt welding	Connecting nipple for screwed, plugged or socket-welded connection	Connecting socket for screwed, plugged or socket-welded connection
		
a = Insertion length dimension (e.g. L, L1 etc.)	a = Insertion length dimension (e.g. L, L1 etc.)	a = Insertion length dimension (e.g. L, L1 etc.)

### Named isolated points

Designation	Purpose	Comment	Position in coordinate system
!	Connecting point	Fitting point	in origin (0,0,0)
2	Auxiliary point		X = 0, Y = 0, Z > 0

### Required attributes for entries into database or catalogue

The entering of attribute values and the part type selection should be performed using the PAA Editor.

Values need to be entered for at least the following attributes:

Attribute	Description
BENENNUNG	Designation of part
NORMBEZEICHNUNG	Standard designation of the part. An entry is mandatory, even if the part corresponds to no standard
NENNWEITE	Nominal diameter, Connection "!"
D_AUSSEN	Outer diameter, Connection "!"
WANDDICKE	Wall thickness, Connection "!"
<b>Additionally (only if the corresponding standard uses nominal diameters in inches):</b>	
NPS_INCH	Nominal diameter (inches) (e.g. 1 1/2", the " consists of two "

Attribute	Description																						
	characters), Connection “!“																						
ANSCHLUSSART	Connection type, Connection “!“																						
Possible values of the attribute ANSCHLUSSART (CONNECTION_TYPE):.																							
<table border="0"> <tr><td>1000x</td><td>Butt-welded</td></tr> <tr><td>2000x</td><td>Flange connection</td></tr> <tr><td>2100x</td><td>Flange with groove connection</td></tr> <tr><td>2200x</td><td>Flange with notch connection</td></tr> <tr><td>2040x</td><td>Flange connection of a part that is not a flange itself. The part has a loose flange that is modelled as a sub-part and has no own article master attached to this connection.</td></tr> <tr><td>3100x</td><td>Screwed, nipple</td></tr> <tr><td>3200x</td><td>Screwed, socket</td></tr> <tr><td>4100x</td><td>Plugged, nipple</td></tr> <tr><td>4200x</td><td>Plugged, socket</td></tr> <tr><td>5100x</td><td>Socket-welded, nipple</td></tr> <tr><td>5200x</td><td>Socket-welded, socket</td></tr> </table>	1000x	Butt-welded	2000x	Flange connection	2100x	Flange with groove connection	2200x	Flange with notch connection	2040x	Flange connection of a part that is not a flange itself. The part has a loose flange that is modelled as a sub-part and has no own article master attached to this connection.	3100x	Screwed, nipple	3200x	Screwed, socket	4100x	Plugged, nipple	4200x	Plugged, socket	5100x	Socket-welded, nipple	5200x	Socket-welded, socket	<p><b>Provide auxiliary part when fitting part</b></p> <p>If appropriately preset in the ANSCHLUSSART (CONNECTION_TYPE) attribute for a connection, the part will provide and connect an auxiliary part of the standard specified in the attribute for the connection when being fitted. For example, if the part has a flange connection and the corresponding counter-flange is required, the content of the ANSCHLUSSART (CONNECTION_TYPE) attribute could look as follows:  <b>20002 1 5100010 EN 1092-1/11/A/PN 40</b>  <b>EN 1092-1/11/A/PN 40</b> is the standard designation with which the flange is to be entered into the database.</p>
1000x	Butt-welded																						
2000x	Flange connection																						
2100x	Flange with groove connection																						
2200x	Flange with notch connection																						
2040x	Flange connection of a part that is not a flange itself. The part has a loose flange that is modelled as a sub-part and has no own article master attached to this connection.																						
3100x	Screwed, nipple																						
3200x	Screwed, socket																						
4100x	Plugged, nipple																						
4200x	Plugged, socket																						
5100x	Socket-welded, nipple																						
5200x	Socket-welded, socket																						
<p>The last character (x) provides information about the meaning of the supplement:  <b>0</b>=No supplement  <b>2</b>= The supplement consists of connection number, part type, ID, and standard of the part to be connected                  The prefixed connection number indicates the connection with which the auxiliary part is to be attached to the current connection.</p>																							
<p> Please also read the information given in the paragraphs Connection type ID with priority information and Connection type ID - List of part standards.</p>																							

### Part Type: Knee

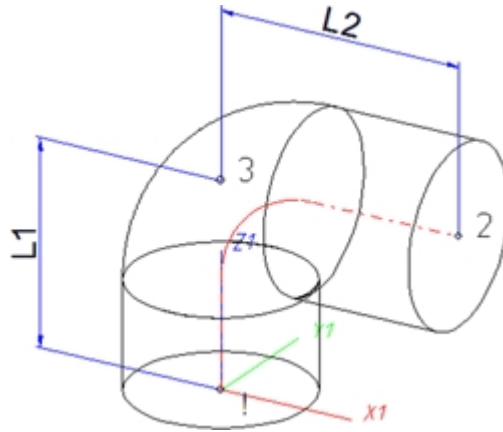

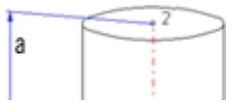
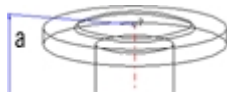
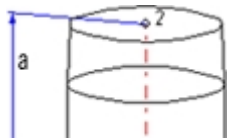
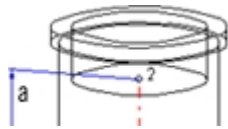
Position of connecting points and determination of insertion lengths for various connection types			
Connection for butt welding	Flange connection	Connecting nipple for screwed, plugged or socket-welded connection	Connecting socket for screwed, plugged or socket-welded connection
			
a = Insertion length dimension (e.g. L, L1 etc.)	a = Insertion length dimension (e.g. L, L1 etc.)	a = Insertion length dimension (e.g. L, L1 etc.)	a = Insertion length dimension (e.g. L, L1 etc.)

### Named isolated points

Designation	Purpose	Comment	Position in coordinate system
!	Connecting point	Fitting point	in origin (0,0,0)
2	Connecting point		$X > 0, Y = 0, Z > 0$
3	Corner point		$X = 0, Y = 0, Z > 0$

### Required attributes for entries into database or catalogue

The entering of attribute values and the part type selection should be performed using the PAA Editor.

Values need to be entered for at least the following attributes:

Attribute	Description
BENENNUNG	Designation of part
NORMBEZEICHNUNG	Standard designation of the part. An entry is mandatory, even if the part corresponds to no standard.



Attribute	Description
NENNWEITE	Nominal diameter, Connection "1"
NENNWEITE2	Nominal diameter, Connection "2"
WINKEL	Angle between the distances "3" -> "1" and "3" ->"2"
<b>Additionally (only if the corresponding standard uses nominal diameters in inches):</b>	
NPS_INCH	Nominal diameter (inches) (e.g. 1 1/2", the " consists of two " characters) , Connection "1"
NPS2_INCH	Nominal diameter (inches), Connection "2"
<b>These parameters are to be considered for all connection types except for flange connections. For connecting sockets they refer to the pipe to be inserted:</b>	
D_AUSSEN	Outer diameter, Connection "1"
D2_AUSSEN	Outer diameter, Connection "2"
WANDDICKE	Wall thickness, Connection "1"
WANDDICKE2	Wall thickness, Connection "2"
ANSCHLUSSART	Connection type, Connection "1"
ANSCHLUSSART2	Connection type, Connection "2"
Possible values of the attribute ANSCHLUSSART (CONNECTION_TYPE):	
1000x	Butt-welded
2000x	Flange connection
2100x	Flange with groove connection
2200x	Flange with notch connection
2040x	Flange connection of a part that is not a flange itself. The part has a loose flange that is modelled as a sub-part and has no own article master attached to this connection.
3100x	Screwed, nipple
3200x	Screwed, socket
4100x	Plugged, nipple
4200x	Plugged, socket
5100x	Socket-welded, nipple
5200x	Socket-welded, socket
<p>The last character (x) provides information about the meaning of the supplement:  <b>0</b>=No supplement  <b>2</b>= The supplement consists of connection number, part type, ID, and standard of the part to be connected                      The prefixed connection number indicates the connection with which the auxiliary part is to be attached to the current connection.</p>	
<p> Please also read the information given in the paragraphs Connection type ID with priority information and Connection type ID - List of part standards.</p>	

### Part Type: Cross

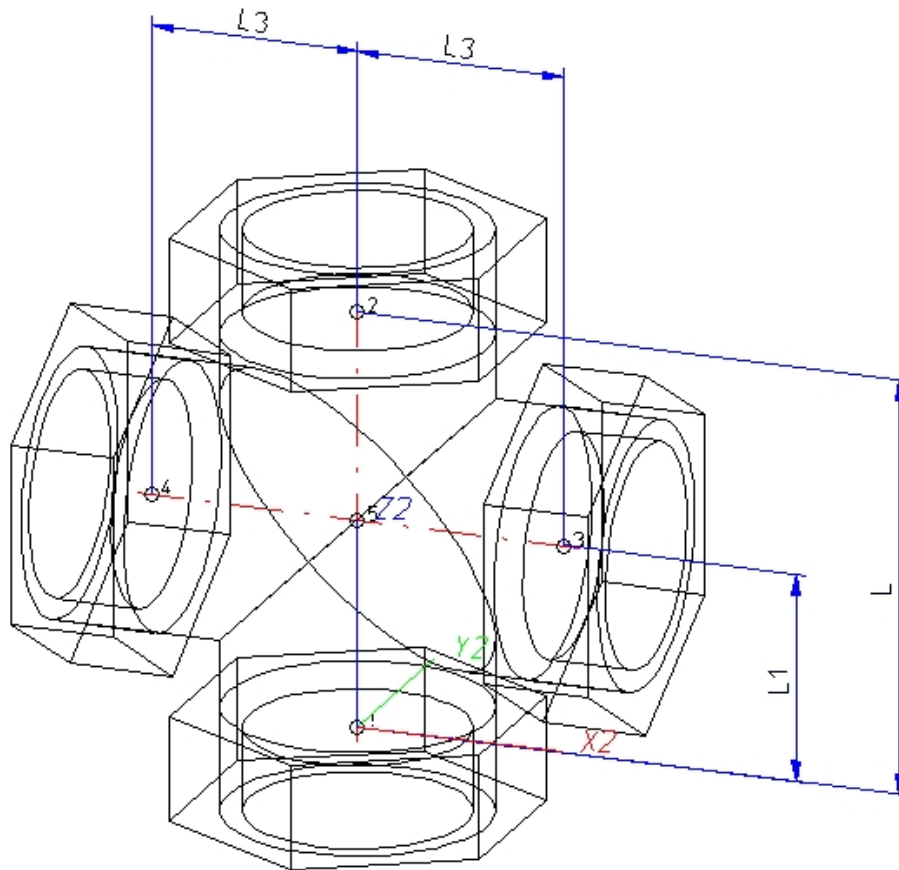

Position of connecting points and determination of insertion lengths for various connection types			
Connection for butt welding	Flange connection	Connecting nipple for screwed, plugged or socket-welded connection	Connecting socket for screwed, plugged or socket-welded connection
a = Insertion length dimension (e.g. L, L1 etc.)	a = Insertion length dimension (e.g. L, L1 etc.)	a = Insertion length dimension (e.g. L, L1 etc.)	a = Insertion length dimension (e.g. L, L1 etc.)

**Named isolated points**

Designation	Purpose	Comment	Position in coordinate system
!	Connecting point	Fitting point	in origin (0,0,0)
2	Connecting point		X = 0, Y = 0, Z > 0
3	Corner point	on branch	X > 0, Y = 0, Z > 0
4	Corner point	on branch	X < 0, Y = 0, Z > 0

**Required attributes for entries into database or catalogue**

The entering of attribute values and the part type selection should be performed using the PAA Editor.

Values need to be entered for at least the following attributes:

Attribute	Description
BENENNUNG	Designation of part
NORMBEZEICHNUNG	Standard designation of the part. An entry is mandatory, even if the part corresponds to no standard.
NENNWEITE	Nominal diameter, Connection "!" and "2"
NENNWEITE3	Nominal diameter, Connection "3" and "4"
<b>Additionally (only if the corresponding standard uses nominal diameters in inches):</b>	
NPS_INCH	Nominal diameter (inches) (e.g. 1 1/2", the " " consists of two " " characters) , Connection "!" and "2"
NPS3_INCH	Nominal diameter (inches), Connection "3" and "4"
<b>These parameters are to be considered for all connection types except for flange connections. For connecting sockets they refer to the pipe to be inserted:</b>	
D_AUSSEN	Outer diameter, Connection "!" and "2"
D3_AUSSEN	Outer diameter, Connection "3" and "4"
WANDDICKE	Wall thickness, Connection "!" and "2"
WANDDICKE3	Wall thickness, Connection "3" and "4"
ANSCHLUSSART	Connection type, Connection "!", "2", "3" and "4"
Possible values of the attribute ANSCHLUSSART (CONNECTION_TYPE):.	

Attribute	Description
1000x	Butt-welded
2000x	Flange connection
2100x	Flange with groove connection
2200x	Flange with notch connection
2040x	<p>Flange connection of a part that is not a flange itself. The part has a loose flange that is modelled as a sub-part and has no own article master attached to this connection.</p>
3100x	Screwed, nipple
3200x	Screwed, socket
4100x	Plugged, nipple
4200x	Plugged, socket
5100x	Socket-welded, nipple
5200x	Socket-welded, socket
<p>The last character (x) provides information about the meaning of the supplement:</p>	
<p><b>0</b>=No supplement</p>	
<p><b>2</b>= The supplement consists of connection number, part type, ID, and standard of the part to be connected</p>	
<p>The prefixed connection number indicates the connection with which the auxiliary part is to be attached to the current connection.</p>	
<p> Please also read the information given in the paragraphs Connection type ID with priority information and Connection type ID - List of part standards.</p>	

### Part Type: Gauge part

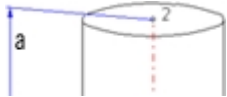
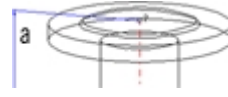
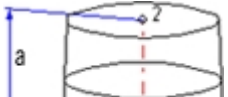
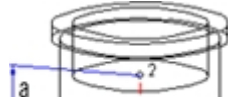

Position of connecting points and determination of insertion lengths for various connection types			
Connection for butt welding	Flange connection	Connecting nipple for screwed, plugged or socket-welded connection	Connecting socket for screwed, plugged or socket-welded connection
			
a = Insertion length dimension (e.g. L, L1 etc.)	a = Insertion length dimension (e.g. L, L1 etc.)	a = Insertion length dimension (e.g. L, L1 etc.)	a = Insertion length dimension (e.g. L, L1 etc.)

### Named isolated points

Designation	Purpose	Comment	Position in coordinate system
!	Connecting point	Fitting point	in origin (0,0,0)
2	Auxiliary point or Connecting point	-	X > 0, Y = 0, Z > 0

### Required attributes for entries into database or catalogue

The entering of attribute values and the part type selection should be performed using the PAA Editor.

Values need to be entered for at least the following attributes:

Attribute	Description
BENENNUNG	Designation of part
NORMBEZEICHNUNG	Standard designation of the part. An entry is mandatory, even if the part corresponds to no standard.

Attribute	Description
NENNWEITE	Nominal diameter, Connection "!"
<b>Additionally (only if the corresponding standard uses nominal diameters in inches):</b>	
NPS_INCH	Nominal diameter (inches) (e.g. 1 1/2", the " consists of two " characters) , Connection "!"
<b>These parameters are to be considered for all connection types except for flange connections. For connecting sockets they refer to the pipe to be inserted:</b>	
D_AUSSEN	Outer diameter, Connection "!"
WANDDICKE	Wall thickness, Connection "!"
ANSCHLUSSART	Connection type, Connection "!"
ANSCHLUSSART2	Connection type, Connection "2" (= "0", if only one connection exists)
Possible values of the attribute ANSCHLUSSART (CONNECTION_TYPE):.	
1000x	Butt-welded
2000x	Flange connection
2100x	Flange with groove connection
2200x	Flange with notch connection
2040x	Flange connection of a part that is not a flange itself. The part has a loose flange that is modelled as a sub-part and has no own article master attached to this connection.
3100x	Screwed, nipple
3200x	Screwed, socket
4100x	Plugged, nipple
4200x	Plugged, socket
5100x	Socket-welded, nipple
5200x	Socket-welded, socket
<p><b>Provide auxiliary part when fitting part</b></p> <p>If appropriately preset in the ANSCHLUSSART (CONNECTION_TYPE) attribute for a connection, the part will provide and connect an auxiliary part of the standard specified in the attribute for the connection when being fitted. For example, if the part has a flange connection and the corresponding counter-flange is required, the content of the ANSCHLUSSART (CONNECTION_TYPE) attribute could look as follows:  <b>20002 1 5100010 EN 1092-1/11/A/PN 40</b>  <b>EN 1092-1/11/A/PN 40</b> is the standard designation with which the flange is to be entered into the database.</p>	
<p>The last character (x) provides information about the meaning of the supplement:  <b>0</b>=No supplement  <b>2</b>= The supplement consists of connection number, part type, ID, and standard of the part to be connected                      The prefixed connection number indicates the connection with which the auxiliary part is to be attached to the current connection.</p>	
 Please also read the information given in the paragraphs Connection type ID with priority information and Connection type ID - List of part standards.	

### Part Type: Reducer, Concentric

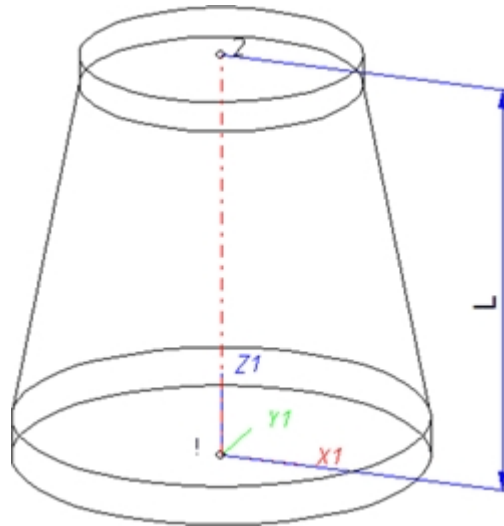

Position of connecting points and determination of insertion lengths for various connection types			
Connection for butt welding	Flange connection	Connecting nipple for screwed, plugged or socket-welded connection	Connecting socket for screwed, plugged or socket-welded connection
a = Insertion length dimension (e.g. L, L1 etc.)	a = Insertion length dimension (e.g. L, L1 etc.)	a = Insertion length dimension (e.g. L, L1 etc.)	a = Insertion length dimension (e.g. L, L1 etc.)

#### Named isolated points

Designation	Purpose	Comment	Position in coordinate system
!	Connecting point	Fitting point	in origin (0,0,0)
2	Connecting point		X = 0, Y = 0, Z > 0

#### Required attributes for entries into database or catalogue

The entering of attribute values and the part type selection should be performed using the PAA Editor.

Values need to be entered for at least the following attributes:

Attribute	Description
BENENNUNG	Designation of part
NORMBEZEICHNUNG	Standard designation of the part. An entry is mandatory, even if the part corresponds to no standard.

Attribute	Description
NENNWEITE	Nominal diameter, Connection "1"
NENNWEITE2	Nominal diameter, Connection "2"
<b>Additionally (only if the corresponding standard uses nominal diameters in inches):</b>	
NPS_INCH	Nominal diameter (inches) (e.g. 1 1/2", the " consists of two " characters), Connection "1"
NPS2_INCH	Nominal diameter (inches), Connection "2"
<b>These parameters are to be considered for all connection types except for flange connections. For connecting sockets they refer to the pipe to be inserted:</b>	
D_AUSSEN	Outer diameter, Connection "1"
D2_AUSSEN	Outer diameter, Connection "2"
WANDDICKE	Wall thickness, Connection "1"
WANDDICKE2	Wall thickness, Connection "2"
ANSCHLUSSART	Connection type, Connection "1"
ANSCHLUSSART2	Connection type, Connection "2"
Possible values of the attribute ANSCHLUSSART (CONNECTION_TYPE):	
1000x	Butt-welded
2000x	Flange connection
2100x	Flange with groove connection
2200x	Flange with notch connection
2040x	Flange connection of a part that is not a flange itself. The part has a loose flange that is modelled as a sub-part and has no own article master attached to this connection.
3100x	Screwed, nipple
3200x	Screwed, socket
4100x	Plugged, nipple
4200x	Plugged, socket
5100x	Socket-welded, nipple
5200x	Socket-welded, socket
<p>The last character (x) provides information about the meaning of the supplement:  <b>0</b> = No supplement  <b>2</b> = The supplement consists of connection number, part type, ID, and standard of the part to be connected                      The prefixed connection number indicates the connection with which the auxiliary part is to be attached to the current connection.</p>	
<p><b>Provide auxiliary part when fitting part</b>                      If appropriately preset in the ANSCHLUSSART (CONNECTION_TYPE) attribute for a connection, the part will provide and connect an auxiliary part of the standard specified in the attribute for the connection when being fitted. For example, if the part has a flange connection and the corresponding counter-flange is required, the content of the ANSCHLUSSART (CONNECTION_TYPE) attribute could look as follows:  <b>20002 1 5100010 EN 1092-1/11/A/PN 40</b>  <b>EN 1092-1/11/A/PN 40</b> is the standard designation with which the flange is to be entered into the database.</p>	
<p> Please also read the information given in the paragraphs Connection type ID with priority information and Connection type ID - List of part standards.</p>	



### Part Type: Reducer, Excentric

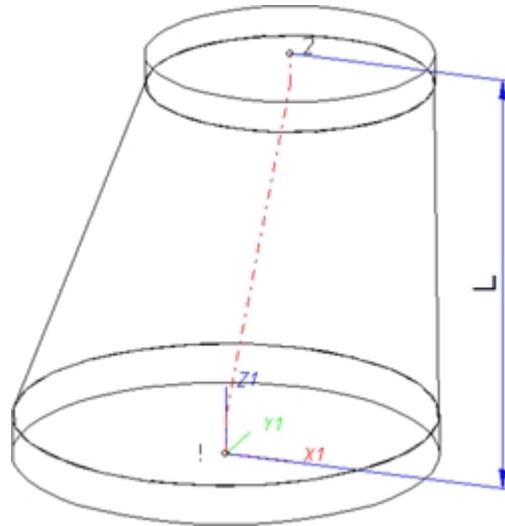

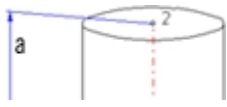
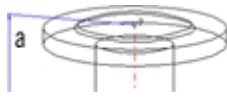
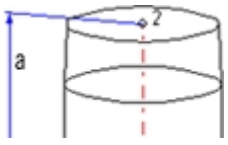
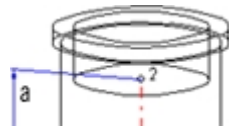
Position of connecting points and determination of insertion lengths for various connection types			
Connection for butt welding	Flange connection	Connecting nipple for screwed, plugged or socket-welded connection	Connecting socket for screwed, plugged or socket-welded connection
			
a = Insertion length dimension (e.g. L, L1 etc.)	a = Insertion length dimension (e.g. L, L1 etc.)	a = Insertion length dimension (e.g. L, L1 etc.)	a = Insertion length dimension (e.g. L, L1 etc.)

#### Named isolated points

Designation	Purpose	Comment	Position in coordinate system
!	Connecting point	Fitting point	in origin (0,0,0)
2	Connecting point		$X > 0, Y = 0, Z > 0$

#### Required attributes for entries into database or catalogue

The entering of attribute values and the part type selection should be performed using the PAA Editor.

Values need to be entered for at least the following attributes:

Attribute	Description
BENENNUNG	Designation of part
NORMBEZEICHNUNG	Standard designation of the part. An entry is mandatory, even if the part corresponds to no standard.

Attribute	Description
NENNWEITE	Nominal diameter, Connection "1"
NENNWEITE2	Nominal diameter, Connection "2"
<b>Additionally (only if the corresponding standard uses nominal diameters in inches):</b>	
NPS_INCH	Nominal diameter (inches) (e.g. 1 1/2", the " consists of two " characters), Connection "1"
NPS2_INCH	Nominal diameter (inches), Connection "2"
<b>These parameters are to be considered for all connection types except for flange connections. For connecting sockets they refer to the pipe to be inserted:</b>	
D_AUSSEN	Outer diameter, Connection "1"
D2_AUSSEN	Outer diameter, Connection "2"
WANDDICKE	Wall thickness, Connection "1"
WANDDICKE2	Wall thickness, Connection "2"
ANSCHLUSSART	Connection type, Connection "1"
ANSCHLUSSART2	Connection type, Connection "2"
Possible values of the attribute ANSCHLUSSART (CONNECTION_TYPE):.	
1000x	Butt-welded
2000x	Flange connection
2100x	Flange with groove connection
2200x	Flange with notch connection
2040x	Flange connection of a part that is not a flange itself. The part has a loose flange that is modelled as a sub-part and has no own article master attached to this connection.
3100x	Screwed, nipple
3200x	Screwed, socket
4100x	Plugged, nipple
4200x	Plugged, socket
5100x	Socket-welded, nipple
5200x	Socket-welded, socket
<p><b>Provide auxiliary part when fitting part</b></p> <p>If appropriately preset in the ANSCHLUSSART (CONNECTION_TYPE) attribute for a connection, the part will provide and connect an auxiliary part of the standard specified in the attribute for the connection when being fitted. For example, if the part has a flange connection and the corresponding counter-flange is required, the content of the ANSCHLUSSART (CONNECTION_TYPE) attribute could look as follows:  <b>20002 1 5100010 EN 1092-1/11/A/PN 40</b>  <b>EN 1092-1/11/A/PN 40</b> is the standard designation with which the flange is to be entered into the database.</p>	
<p>The last character (x) provides information about the meaning of the supplement:  <b>0</b>=No supplement  <b>2</b>= The supplement consists of connection number, part type, ID, and standard of the part to be connected                      The prefixed connection number indicates the connection with which the auxiliary part is to be attached to the current connection.</p>	
 Please also read the information given in the paragraphs Connection type ID with priority information and Connection type ID - List of part standards.	

## Part Type: Elbow

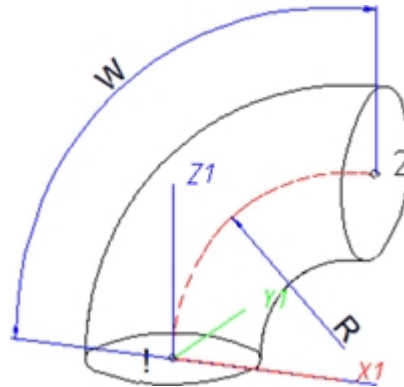

Position of connecting points and determination of insertion lengths for various connection types			
Connection for butt welding	Flange connection	Connecting nipple for screwed, plugged or socket-welded connection	Connecting socket for screwed, plugged or socket-welded connection
a = Insertion length dimension (e.g. L, L1 etc.)	a = Insertion length dimension (e.g. L, L1 etc.)	a = Insertion length dimension (e.g. L, L1 etc.)	a = Insertion length dimension (e.g. L, L1 etc.)

### Named isolated points

Designation	Purpose	Comment	Position in coordinate system
!	Connecting point	Fitting point	in origin(0,0,0)
2	Connecting point		X > 0, Y = 0, Z > 0

### Required attributes for entries into database or catalogue

The entering of attribute values and the part type selection should be performed using the PAA Editor.

Values need to be entered for at least the following attributes:

Attribute	Description
BENENNUNG	Designation of part
NORMBEZEICHNUNG	Standard designation of the part. An entry is mandatory, even if the part corresponds to no standard.
BELIEBIG_TEILBAR	Indicates whether a cutting to length of the elbow is permissible.

Attribute	Description
NENNWEITE	Nominal diameter, Connection “1” and “2”
WINKEL	Angle
KRUEMMUNG	Bend radius
<b>Additionally (only if the corresponding standard uses nominal diameters in inches):</b>	
NPS_INCH	Nominal diameter (inches) (e.g. 1 1/2", the " consists of two " characters), Connection “1” and “2”
<b>These parameters are to be considered for all connection types except for flange connections. For connecting sockets they refer to the pipe to be inserted:</b>	
D_AUSSEN (	Outer diameter, Connection “1” and “2”
WANDDICKE	Wall thickness, Connection “1” and “2”
ANSCHLUSSART	Connection type, Connection “1” and “2” The connection types on both ends must be identical.
Possible values of the attribute ANSCHLUSSART (CONNECTION_TYPE):.	
1000x	Butt-welded
2000x	Flange connection
2100x	Flange with groove connection
2200x	Flange with notch connection
2040x	Flange connection of a part that is not a flange itself. The part has a loose flange that is modelled as a sub-part and has no own article master attached to this connection.
3100x	Screwed, nipple
3200x	Screwed, socket
4100x	Plugged, nipple
4200x	Plugged, socket
5100x	Socket-welded, nipple
5200x	Socket-welded, socket
<p><b>Provide auxiliary part when fitting part</b></p> <p>If appropriately preset in the ANSCHLUSSART (CONNECTION_TYPE) attribute for a connection, the part will provide and connect an auxiliary part of the standard specified in the attribute for the connection when being fitted. For example, if the part has a flange connection and the corresponding counter-flange is required, the content of the ANSCHLUSSART (CONNECTION_TYPE) attribute could look as follows:  <b>20002 1 5100010 EN 1092-1/11/A/PN 40</b>  <b>EN 1092-1/11/A/PN 40</b> is the standard designation with which the flange is to be entered into the database.</p>	
<p>The last character (x) provides information about the meaning of the supplement:  <b>0</b>=No supplement  <b>2</b>= The supplement consists of connection number, part type, ID, and standard of the part to be connected                      The prefixed connection number indicates the connection with which the auxiliary part is to be attached to the current connection.</p>	
 Please also read the information given in the paragraphs Connection type ID with priority information and Connection type ID - List of part standards.	

## Part Type: Pipe Clamp

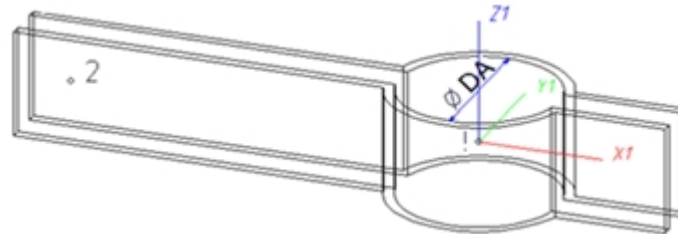

### Named isolated points

Designation	Purpose	Comment	Position in coordinate system
!	Fitting point	Reference point placed on the centre line of a pipe during fitting	in origin (0,0,0)
2	Auxiliary point		$X < 0, Y = 0, Z = 0$

### Required attributes for entries into database or catalogue

The entering of attribute values and the part type selection should be performed using the PAA Editor.

Values need to be entered at least for the attributes shown below:

#### Possibility 1:

Attribute	Description
BENENNUNG	Designation of part
NORMBEZEICHNUNG	Standard designation of the part. An entry is mandatory, even if the part corresponds to no standard.
NENNWEITE	Nominal diameter
D_AUSSEN	Outer diameter of pipe (see DA in drawing)
<b>Additionally (only if the corresponding standard uses nominal diameters in inches):</b>	
NPS_INCH	Nominal diameter (inches) (e.g. 1 1/2", the " consists of two " characters)

#### Possibility 2:

Attribute	Description
BENENNUNG	Designation of part
NORMBEZEICHNUNG	Standard designation of the part. An entry is mandatory, even if the part corresponds to no standard.
D_AUSSEN	Largest possible outer diameter of pipe that is still suitable for pipe clamp

Attribute	Description
D2_AUSSEN	Smallest possible outer diameter of pipe that is still suitable for pipe clamp
NENNWEITE	Nominal diameter matching D_AUSSEN
<b>Additionally (only if the corresponding standard uses nominal diameters in inches):</b>	
NPS_INCH	Nominal diameter (inches) (e.g. 1 1/2", the " consists of two " characters)



For the insertion of a pipe clamp having these two outer diameter attributes the **Also use Outer diameter 2 as search criterion for pipe clamps** checkbox on the **Part search** tab of the **Plant Engineering Settings** dialogue must be active.

## Part Type: Vessels, Pumps, Other components

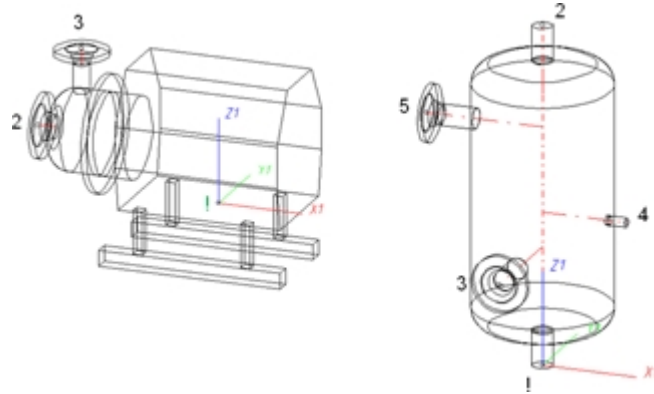

### Named isolated points

Designation	Purpose	Comment	Position in coordinate system
!	Connecting point or Auxiliary point	Fitting point	in origin (0,0,0)
2, 3, 4 etc., unambiguous within the part	Connecting points or Auxiliary points		arbitrary

Connecting points should preferably be created via the **Component connection** function or by the insertion of nozzles.

Each component connection (and the fitting point, if it is an auxiliary point) needs to be located in a plane belonging to the part. It needs however not be located within the surface boundary.

### Example

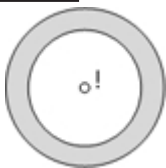

If the connecting point is located in the plane of the ring surface, the surface condition is fulfilled.

Caution: It would also be fulfilled if the point would be located in the same plane, but outside of the ring.

To assign an unambiguous orientation to a connection, a connecting point must not fulfil the surface condition for several surfaces at once.

### Required attributes for entries into database or catalogue

The entering of attribute values and the part type selection should be performed using the PAA Editor.

Values need to be entered for at least the following attributes:

Attribute	Description
BENENNUNG	Designation of part
NORMBEZEICHNUNG	Standard designation of the part. An entry is mandatory, even if the part corresponds to no standard.

## Part Type: Nozzle

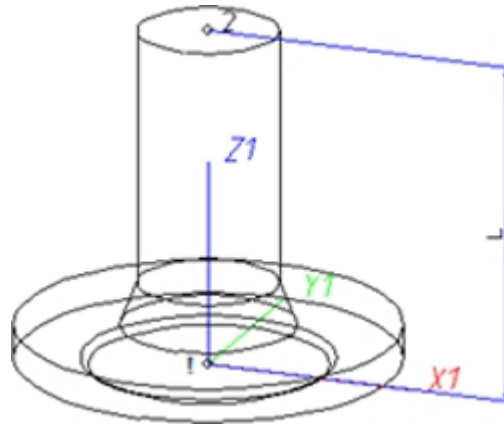

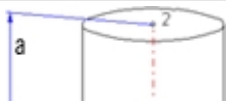
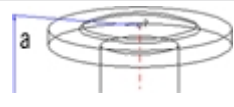
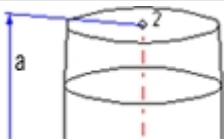
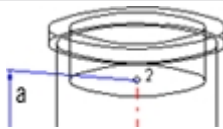
Position of connecting points and determination of insertion lengths for various connection types			
Connection for butt welding	Flange connection	Connecting nipple for screwed, plugged or socket-welded connection	Connecting socket for screwed, plugged or socket-welded connection
			
a = Insertion length dimension (e.g. L, L1 etc.)	a = Insertion length dimension (e.g. L, L1 etc.)	a = Insertion length dimension (e.g. L, L1 etc.)	a = Insertion length dimension (e.g. L, L1 etc.)

### Named isolated points

Designation	Purpose	Comment	Position in coordinate system
!	Connecting point	Fitting point	in origin (0,0,0)
2	Connecting point		X = 0, Y = 0, Z > 0

### Required attributes for entries into database or catalogue

The entering of attribute values and the part type selection should be performed using the PAA Editor.

Values need to be entered for at least the following attributes:

Attribute	Description
BENENNUNG	Designation of part
NORMBEZEICHNUNG	Standard designation of the part. An entry is mandatory, even if the part corresponds to no standard.
NENNWEITE	Nominal diameter, Connection “!” and “2”
D_AUSSEN	Outer diameter, Connection [“!” and] “2”



Attribute	Description
WANDDICKE	Wall thickness, Connection ["1" and] "2"
<b>Additionally (only if the corresponding standard uses nominal diameters in inches):</b>	
NPS_INCH	Nominal diameter (inches) (e.g. 1 1/2", the " consists of two " characters), Connections "1" and "2"
ANSCHLUSSART	Connection type, Connection "1"
ANSCHLUSSART2	Connection type, Connection "2" (value always 10000)
Possible values of the attribute ANSCHLUSSART (CONNECTION_TYPE):.	
1000x	Butt-welded
2000x	Flange connection
2100x	Flange with groove connection
2200x	Flange with notch connection
2040x	Flange connection of a part that is not a flange itself. The part has a loose flange that is modelled as a sub-part and has no own article master attached to this connection.
3100x	Screwed, nipple
3200x	Screwed, socket
4100x	Plugged, nipple
4200x	Plugged, socket
5100x	Socket-welded, nipple
5200x	Socket-welded, socket
<p>The last character (x) provides information about the meaning of the supplement:  <b>0</b>=No supplement  <b>2</b>= The supplement consists of connection number, part type, ID, and standard of the part to be connected                      The prefixed connection number indicates the connection with which the auxiliary part is to be attached to the current connection.</p>	
<p> Please also read the information given in the paragraphs Connection type ID with priority information and Connection type ID - List of part standards.</p>	

## Part Type: Other Pipe Part

Up to 4 connections are possible for this part type.

The connections "1" and "2" need to be located on the Z-axis. The position of further connections is arbitrary. However, connections "3" and "4" cannot process guidelines during part insertion. The creation of guidelines starting from connections "3" and "4" can only be performed subsequently. Therefore, you will only have the following fitting options:

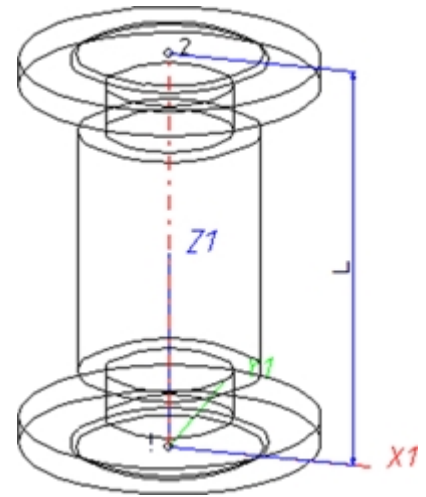
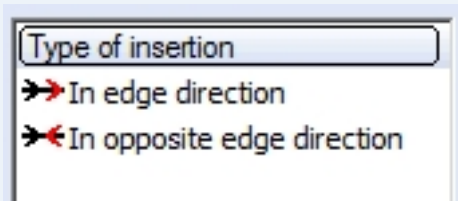

Example: Compensator with flanges

### Position of connecting points and determination of insertion lengths for various connection types

Connection for butt welding	Flange connection	Connecting nipple for screwed, plugged or socket-welded connection	Connecting socket for screwed, plugged or socket-welded connection
a = Insertion length dimension (e.g. L, L1 etc.)	a = Insertion length dimension (e.g. L, L1 etc.)	a = Insertion length dimension (e.g. L, L1 etc.)	a = Insertion length dimension (e.g. L, L1 etc.)

### Named isolated points

Designation	Purpose	Comment	Position in coordinate system
!	Connecting point	Fitting point	in origin (0,0,0)
2	Connecting point		X = 0, Y = 0, Z > 0
3	Connecting point	optional	arbitrary
4	Connecting point	optional	arbitrary

### Required attributes for entries into database or catalogue

The entering of attribute values and the part type selection should be performed using the PAA Editor.

For a part with two connections, values need to be entered for at least the following attributes:

Attribute	Description
BENENNUNG	Designation of part
NORMBEZEICHNUNG	Standard designation of the part.

Attribute	Description
	An entry is mandatory, even if the part corresponds to no standard.
NENNWEITE	Nominal diameter, Connection “!” and “2“
<b>Additionally (only if the corresponding standard uses nominal diameters in inches):</b>	
NPS_INCH	Nominal diameter (inches) (e.g. 1 1/2", the " consists of two " characters), Connection “!” and “2“
<b>These parameters are to be considered for all connection types except for flange connections. For connecting sockets they refer to the pipe to be inserted:</b>	
D_AUSSEN	Outer diameter, Connection “!” and “2“
WANDDICKE	Wall thickness, Connection “!” and “2“
ANSCHLUSSART	Connection type, Connection “!” and “2“
Possible values of the attribute ANSCHLUSSART (CONNECTION_TYPE):..	
1000x	Butt-welded
2000x	Flange connection
2100x	Flange with groove connection
2200x	Flange with notch connection
2040x	Flange connection of a part that is not a flange itself. The part has a loose flange that is modelled as a sub-part and has no own article master attached to this connection.
3100x	Screwed, nipple
3200x	Screwed, socket
4100x	Plugged, nipple
4200x	Plugged, socket
5100x	Socket-welded, nipple
5200x	Socket-welded, socket
<p>The last character (x) provides information about the meaning of the supplement:  <b>0</b>=No supplement  <b>2</b>= The supplement consists of connection number, part type, ID, and standard of the part to be connected                      The prefixed connection number indicates the connection with which the auxiliary part is to be attached to the current connection</p>	
<p> Please also read the information given in the paragraphs Connection type ID with priority information and Connection type ID - List of part standards.</p>	

As mentioned above, the part can have up to 4 connections. If a connection "4" exists, it needs to have the same properties (nominal diameter, outer diameter, wall thickness, connection type) as connection "3". For three connections, different properties can be preset:

Attribute	Description
BENENNUNG	Designation of part
NORMBEZEICHNUNG	Standard designation of the part. An entry is mandatory, even if the part corresponds to no standard.
NENNWEITE	Nominal diameter, Connection "1"
NENNWEITE2	Nominal diameter, Connection "2"
NENNWEITE3	Nominal diameter, Connection "3" [and "4"]
<b>Additionally (only if the corresponding standard uses nominal diameters in inches):</b>	
NPS_INCH	Nominal diameter (inches) (e.g. 1 1/2", the " consists of two " characters), Connection "1" and "2"
NPS2_INCH	Nominal diameter (inches), Connection "2"
NPS3_INCH	Nominal diameter (inches), Connection "3" [and "4"]
<b>These parameters are to be considered for all connection types except for flange connections. For connecting sockets they refer to the pipe to be inserted:</b>	
D_AUSSEN	Outer diameter, Connection "1"
D2_AUSSEN	Outer diameter, Connection "2"
D3_AUSSEN	Outer diameter, Connection "3" [and "4"]
WANDDICKE	Wall thickness, Connection "1"
WANDDICKE2	Wall thickness, Connection "2"
WANDDICKE3	Wall thickness, Connection "3" [and "4"]
ANSCHLUSSART	Connection type for all connections
<i>ANSCHLUSSART2</i>	<i>Connection type for Connection "2", if different from that for Connection "1"</i>
<i>ANSCHLUSSART3</i>	<i>Connection type for Connection "3" [and "4"], if different from that for Connection "2"</i>

### Part Type: T-Piece

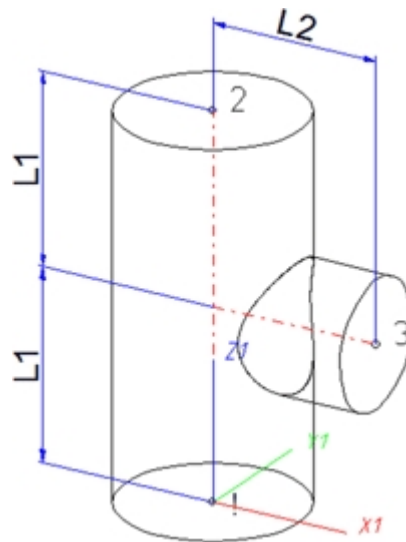

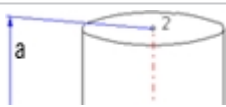
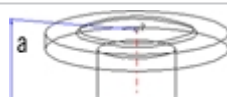
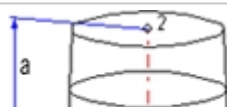
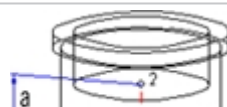
Position of connecting points and determination of insertion lengths for various connection types			
Connection for butt welding	Flange connection	Connecting nipple for screwed, plugged or socket-welded connection	Connecting socket for screwed, plugged or socket-welded connection
			
a = Insertion length dimension (e.g. L, L1 etc.)	a = Insertion length dimension (e.g. L, L1 etc.)	a = Insertion length dimension (e.g. L, L1 etc.)	a = Insertion length dimension (e.g. L, L1 etc.)

### Named isolated points

Designation	Purpose	Comment	Position in coordinate system
!	Connecting point	Fitting point	in origin (0,0,0)
2	Connecting point		X = 0, Y = 0, Z > 0
3	Connecting point	on branch	X > 0, Y = 0, Z > 0

### Required attributes for entries into database or catalogue

The entering of attribute values and the part type selection should be performed using the PAA Editor.



Values need to be entered for at least the following attributes:

Attribute	Description
BENENNUNG	Designation of part
NORMBEZEICHNUNG	Standard designation of the part. An entry is mandatory, even if the part corresponds to no

Attribute	Description
	standard.
NENNWEITE	Nominal diameter, Connection “1” and “2”
NENNWEITE3	Nominal diameter, Connection “3”
<b>Additionally (only if the corresponding standard uses nominal diameters in inches):</b>	
NPS_INCH	Nominal diameter (inches) (e.g. 1 1/2”, the " consists of two " characters), Connection “1” and “2”
NPS3_INCH	Nominal diameter (inches), Connection “3”
ANSCHLUSSART	Connection type, Connection “1” and “2”
ANSCHLUSSART3	Connection type, Connection “3”
<b>These parameters are to be considered for all connection types except for flange connections. For connecting sockets they refer to the pipe to be inserted:</b>	
D_AUSSEN	Outer diameter, Connection “1” and “2”
D3_AUSSEN	Outer diameter, Connection “3”
WANDDICKE	Wall thickness, Connection “1”
WANDDICKE3	Wall thickness, Connection “3”
Possible values of the attribute ANSCHLUSSART (CONNECTION_TYPE):	
1000x	Butt-welded
2000x	Flange connection
2100x	Flange with groove connection
2200x	Flange with notch connection
2040x	Flange connection of a part that is not a flange itself. The part has a loose flange that is modelled as a sub-part and has no own article master attached to this connection.
3100x	Screwed, nipple
3200x	Screwed, socket
4100x	Plugged, nipple
4200x	Plugged, socket
5100x	Socket-welded, nipple
5200x	Socket-welded, socket
<p>The last character (x) provides information about the meaning of the supplement:  <b>0</b> = No supplement  <b>2</b> = The supplement consists of connection number, part type, ID, and standard of the part to be connected                      The prefixed connection number indicates the connection with which the auxiliary part is to be attached to the current connection.</p>	
<p><b>Provide auxiliary part when fitting part</b>                      If appropriately preset in the ANSCHLUSSART (CONNECTION_TYPE) attribute for a connection, the part will provide and connect an auxiliary part of the standard specified in the attribute for the connection when being fitted. For example, if the part has a flange connection and the corresponding counter-flange is required, the content of the ANSCHLUSSART (CONNECTION_TYPE) attribute could look as follows:  <b>20002 1 5100010 EN 1092-1/11/A/PN 40</b>  <b>EN 1092-1/11/A/PN 40</b> is the standard designation with which the flange is to be entered into the database.</p>	
<p> Please also read the information given in the paragraphs Connection type ID with priority information and Connection type ID - List of part standards.</p>	

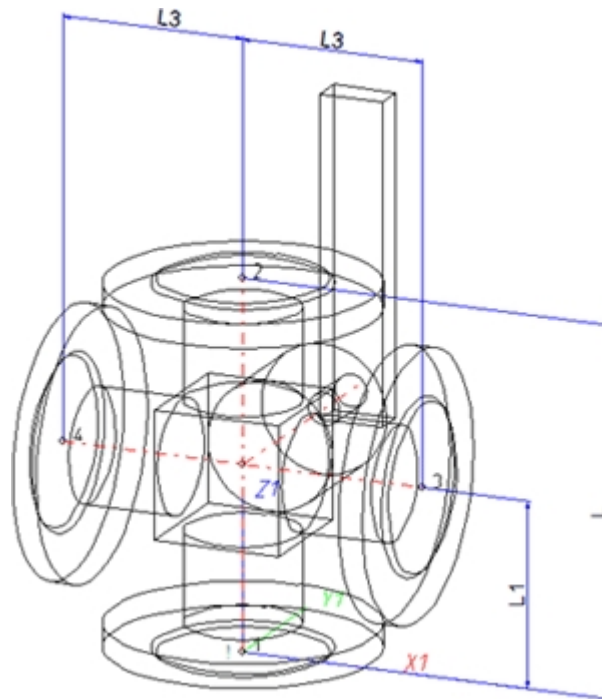
### Part Type: 4-Way Valve

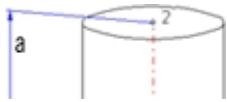
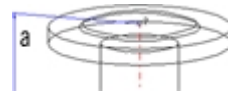

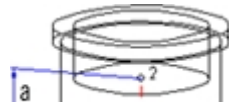
Position of connecting points and determination of insertion lengths for various connection types			
Connection for butt welding	Flange connection	Connecting nipple for screwed, plugged or socket-welded connection	Connecting socket for screwed, plugged or socket-welded connection
			
a = Insertion length dimension (e.g. L, L1 etc.)	a = Insertion length dimension (e.g. L, L1 etc.)	a = Insertion length dimension (e.g. L, L1 etc.)	a = Insertion length dimension (e.g. L, L1 etc.)

#### Named isolated points

Designation	Purpose	Comment	Position in coordinates system
!	Connecting point	Fitting point	in origin (0,0,0)
2	Connecting point		X = 0, Y = 0, Z > 0
3	Connecting point	on branch	X > 0, Y = 0, Z > 0
4	Connecting point	on branch	X < 0, Y = 0, Z > 0

#### Required attributes for entries into database or catalogue

The entering of attribute values and the part type selection should be performed using the PAA Editor.

Values need to be entered for at least the following attributes:

Attribute	Description
BENENNUNG	Designation of part
NORMBEZEICHNUNG	Standard designation of the part (identical for all sub-types!) An entry is mandatory, even if the part corresponds to no standard.
NENNWEITE	Nominal diameter, Connection "1" and "2"
NENNWEITE3	Nominal diameter, Connection "3" and "4"
<b>Additionally (only if the corresponding standard uses nominal diameters in inches):</b>	
NPS_INCH	Nominal diameter (inches) (e.g. 1 1/2", the " consists of two " characters), Connection "1" and "2"
NPS3_INCH	Nominal diameter (inches), Connection "3" and "4"
<b>These parameters are to be considered for all connection types except for flange connections. For connecting sockets they refer to the pipe to be inserted:</b>	
D_AUSSEN	Outer diameter, Connection "1" and "2"
D3_AUSSEN	Outer diameter, Connection "3" and "4"
WANDDICKE	Wall thickness, Connection "1" and "2"
WANDDICKE3	Wall thickness, Connection "3" and "4"
ANSCHLUSSART	Connection type for Connection "1", "2", "3" and "4"
Possible values of the attribute ANSCHLUSSART (CONNECTION_TYPE):	
1000x	Butt-welded
2000x	Flange connection
2100x	Flange with groove connection
2200x	Flange with notch connection
2040x	Flange connection of a part that is not a flange itself. The part has a loose flange that is modelled as a sub-part and has no own article master attached to this connection.
3100x	Screwed, nipple
3200x	Screwed, socket
4100x	Plugged, nipple
4200x	Plugged, socket
5100x	Socket-welded, nipple
5200x	Socket-welded, socket
<p>The last character (x) provides information about the meaning of the supplement:  <b>0</b>=No supplement  <b>2</b>=The supplement consists of connection number, part type, ID, and standard of the part to be connected                      The prefixed connection number indicates the connection with which the auxiliary part is to be attached to the current connection.</p>	



Attribute	Description
	Please also read the information given in the paragraphs Connection type ID with priority information and Connection type ID - List of part standards.

## Part Type: Seal

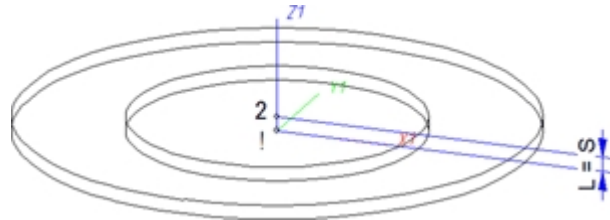

### Named isolated points

Designation	Purpose	Comment	Position in coordinate system
!	Connecting point	Fitting point	in origin (0,0,0)
2	Connecting point		X = 0, Y = 0, Z > 0

### Required attributes for entries into database or catalogue

The entering of attribute values and the part type selection should be performed using the PAA Editor.

Values need to be entered for at least the following attributes:

Attribute	Designation
BENENNUNG	Designation of part
NORMBEZEICHNUNG	Standard designation of the part. An entry is mandatory, even if the part corresponds to no standard.
NENNWEITE	Nominal diameter, Connections "!" and "2"
DICKE	Seal thickness
<b>Additionally (only if the corresponding standard uses nominal diameters in inches):</b>	
NPS_INCH	Nominal diameter (inches) (e.g. 1 1/2", the " consists of two " characters), Connections "!" and "2"
ANSCHLUSSART	Connection types for Connections "!" and "2" (value = 20000 for flange connection)
Possible values of the attribute ANSCHLUSSART (CONNECTION_TYPE):	

Attribute	Designation
2000x Flange connection	<b>Provide auxiliary part when fitting part</b>
2100x Flange with groove connection	If appropriately preset in the ANSCHLUSSART (CONNECTION_
2200x Flange with notch connection	TYPE) attribute for a connection, the part will provide and connect an
2050x Flange connection of a seal that is exclusively intended for the pushed in end of a push-in pipe. The effect of this value is that a loose flange, together with the push-in pipe, will be connected to the seal. The pushed in of the push-in pipe must have the connection type 10xxx.Flange connection.	auxiliary part of the standard specified in the attribute for the connection when being fitted. For example, if the part has a flange connection and the corresponding counter-flange is required, the content of the ANSCHLUSSART (CONNECTION_TYPE) attribute could look as follows: <b>20002 1 5100010 EN 1092-1/11/A/PN 40</b> <b>EN 1092-1/11/A/PN 40</b> is the standard designation with which the flange is to be entered into the database.
The last character (x) provides information about the meaning of the supplement:	
<b>0</b> =No supplement	
<b>2</b> = The supplement consists of connection number, part type, ID, and standard of the part to be connected	
The prefixed connection number indicates the connection with which the auxiliary part is to be attached to the current connection.	
 Please also read the information given in the paragraphs Connection type ID with priority information and Connection type ID - List of part standards.	

## Pressure ranges

In previous versions the nominal pressure was of no significance for the search of matching sealing gaskets. To take pressures ranges into account, the attribute **DRUCK\_MIN** (Minimum pressure) is now available.

When you now search a sealing gasket for a flange, the following, additional search condition will be generated from the nominal pressure **PN** of the flange:

**(MIN\_DRUCK ist unbelegt oder MIN\_DRUCK <= PN) und (DRUCK ist unbelegt oder DRUCK >= PN)**  
(Minimum pressure not specified or Minimum pressure <=PN) and (Minimum pressure not specified or Minimum pressure >=PN)

Sealing gaskets without pressure specifications will thus be handled as if they were suitable for any nominal pressure.

The standard parts that are by default supplied with HiCAD do not include sealing gaskets with a defined pressure range. Therefore, this new feature is currently only relevant for gaskets that have been created by the user. Accordingly, the attribute **DRUCK\_MIN** (Min. pressure) will not be available in the search masks that are by default supplied with HELIOS. If desired, you can add this attribute with the HELIOS Mask Editor.

If you prepare the database for Plant Engineering by clicking the corresponding button in DBPlantDataImport.exe, the attribute **DRUCK\_MIN** will be entered, with the designation **Minimum pressure**, into the database.

### An example from practice:

If you do not want gaskets with an own article number for each pressure level to be created, you can avoid this by means of the **DRUCK\_MIN** attribute.

Furthermore, you have now the option to narrow search results for sealing gaskets by specifying a value for the attribute **DRUCK** (Pressure), e.g. by including only gaskets with a defined pressure in your pipe class.

## Part Type: Fastener

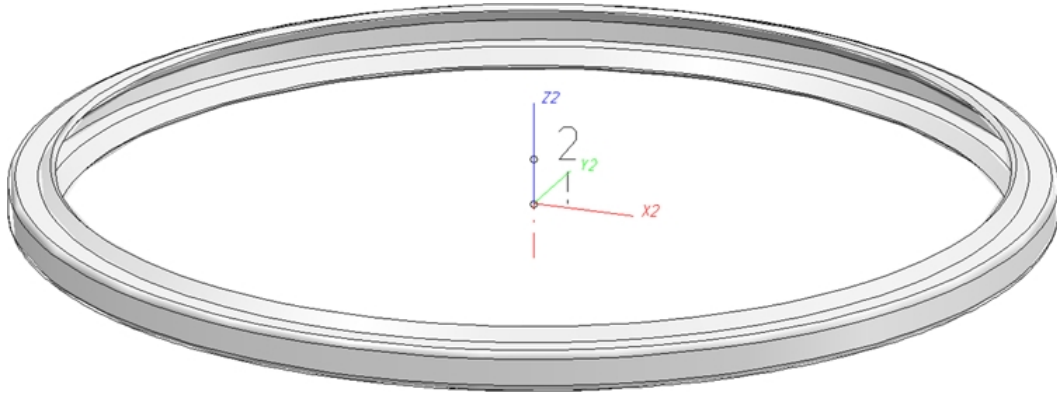

### Named isolated points

Designation	Function	Comment	Position in coordinate system
!	Connecting point	Fitting point	In origin (0,0,0)
2	Auxiliary point		X = 0, Y = 0, Z > 0

The part has no insertion length. When the part is inserted, it will be placed with its fitting point onto a connection of the target part. Connecting point 2 will only be used for a correct alignment.

### Required attributes for entries into database or catalogue

The entering of attribute values and the part type selection should be performed using the PAA Editor.

Values need to be entered for at least the following attributes:

Attribute	Description
BENENNUNG	Designation of the part
NORMBEZEICHNUNG	Standard designation of the part An entry will even be required if the part corresponds to no standard.
ANSCHLUSSART	Connection type for which the fastener is intended.
NENNWEITE	Nominal diameter intended for the fastener.
<b>Additionally (only if the corresponding standard uses nominal diameters in inches):</b>	
NPS_INCH	Nominal diameter in inches (e.g. 1 1/2", the " consist of 2 ' characters)
<b>These additional values make sense if the above attributes should not be sufficient as search criteria:</b>	
D_AUSSEN	Outer diameter for which the fastener is intended
WANDDICKE	Wall thickness for which the fastener is intended
Possible values of the attribute ANSCHLUSSART (CONNECTION_TYPE):	

Attribute	Description
20000	Flange connection
2040x	<p>Flange connection of a part that is not a flange itself. The part has a loose flange that is modelled as a sub-part and has no own article master attached to this connection.</p> <p><b>Please note:</b> The option to specify, via the attribute ANSCHLUSSART, a connected part that will automatically be inserted together with the part (if the corresponding option has been set) is not available here.</p>
42000	Plugged, socket
51000	Socket-welded, nipple
52000	Socket-welded, socket
	<p>Please also read the information given in the paragraphs Connection type ID with priority information and Connection type ID - List of part standards.</p>

### Part Type: Saddle Connection / Elbolet

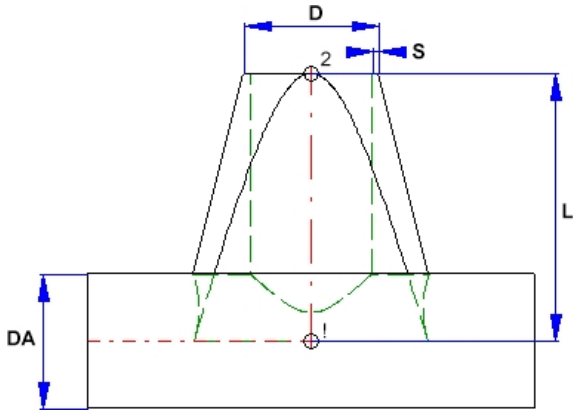

Saddle connection (Example)

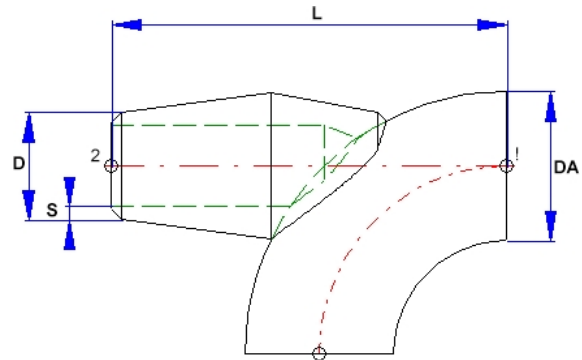

Elbolet (Example)

D=Outer diameter of the nozzle, DA=Outer diameter of the part to which the connection is made, L=Length, S=Wall thickness

Please note that the variable DA (Outer diameter) will be modified upon insertion. It will be applied to the outer diameter of the pipe to which the connection is made. This allows the calculation of the part geometry to match the respective fitting situation. Please check whether the geometry of the constructed saddle connection correctly adjust itself to a modified DA value.

#### Position of connecting points and determination of insertion lengths for various connection types

Connection for butt welding	Flange connection	Connecting nipple for screwed, plugged or socket-welded connection	Connecting socket for screwed, plugged or socket-welded connection
a = Insertion length dimension (e.g. L, L1 etc.)	a = Insertion length dimension (e.g. L, L1 etc.)	a = Insertion length dimension (e.g. L, L1 etc.)	a = Insertion length dimension (e.g. L, L1 etc.)

#### Named isolated points

Designation	Purpose	Comment	Position in coordinate system
!	Connecting point	Fitting point	in origin (0,0,0)
2	Connecting point		X = 0, Y = 0, Z > 0

### Required attributes for entries into database or catalogue

The entering of attribute values and the part type selection should be performed using the PAA Editor.

Values need to be entered for at least the following attributes:

Attribute	Description
BENENNUNG	Designation of part
NORMBEZEICHNUNG	Standard designation of the part. An entry is mandatory, even if the part corresponds to no standard.
NENNWEITE	Nominal diameter, Connection "1" and "2"
<b>Additionally (only if the corresponding standard uses nominal diameters in inches):</b>	
NPS_INCH	Nominal diameter (inches) (e.g. 1 1/2", the " consists of two " characters), Connection "1" and "2"
<b>These sizes are to be considered for all connection types except for the flange connection. For sockets they refer to the pipe to be inserted:</b>	
D_AUSSEN	Outer diameter of the part to which the connection is made. This allows a suitable adjustment of the nozzle.
D2_AUSSEN	Outer diameter of the nozzle, Connection "1" and "2"
WANDDICKE	Wall thickness, Connection "2"
ANSCHLUSSART  ANSCHLUSSART2	Connection type for Connection "1"(and "2") If the same connection type is required at both part ends it will suffice to assign a value to the attribute ANSCHLUSSART.  If different connection types are required at the part ends you need to assign the value of the connection type for Connection 1 to the attribute ANSCHLUSSART, and the connection type for Connection 2 to the attribute ANSCHLUSSART2.
Possible values of the attributes ANSCHLUSSART (CONNECTION_TYPE) and ANSCHLUSSART2 (CONNECTION_TYPE2):	

Attribute	Description
1000x	Butt-welded
2000x	Flange connection
2100x	Flange with groove connection
2200x	Flange with notch connection
2040x	Flange connection of a part that is not a flange itself. The part has a loose flange that is modelled as a sub-part and has no own article master attached to this connection
3100x	Screwed, nipple
3200x	Screwed, socket
4100x	Plugged, nipple
4200x	Plugged, socket
5100x	Socket-welded, nipple
5200x	Socket-welded, socket
<p>The last character (x) provides information about the meaning of the supplement:  <b>0</b> = No supplement  <b>2</b> = The supplement consists of connection number, part type, ID, and standard of the part to be connected                      The prefixed connection number indicates the connection with which the auxiliary part is to be attached to the current connection.</p>	
<p> Please also read the information given in the paragraphs Connection type ID with priority information and Connection type ID - List of part standards.</p>	

Creating Individual Parts: Procedure (PE)



## Rules for the Creation of User-Defined Feature Variants

When creating new, user-defined Feature Variants for Plant Engineering Parts, certain rules, depending on the particular part type, need to be respected.

When using your own variants for flanges or parts with flanges, please read the notes on bolted flange connections!

- Variant for Part Type: Branch
- Variant for Part Type: Valve
- Variant for Part Type: Blank flange
- Variant for Part Type: Double knee
- Variant for Part Type: Three-way valve
- Variant for Part Type: Corner valve
- Variant for Part Type: Flange
- Variant for Part Type: Straight pipe
- Variant for Part Type: Y-piece
- Variant for Part Type: Cap
- Variant for Part Type: Knee
- Variant for Part Type: Cross
- Variant for Part Type: Gauge part
- Variant for Part Type: Reducer, concentric
- Variant for Part Type: Reducer, excentric
- Variant for Part Type: Elbow
- Variant for Part Type: Pipe clamp
- Variant for Part Type: Vessels, Pumps, Other Components
- Variant for Part Type: Nozzles
- Variant for Part Type: Other pipe parts
- Variant for Part Type: T-piece
- Variant for Part Type: 4-way valve
- Variant for Part Type: Seal
- Variant for Part: Fastener
- Variant for Part: Saddle connection / Elbolet

### Variant for Part Type: Branch

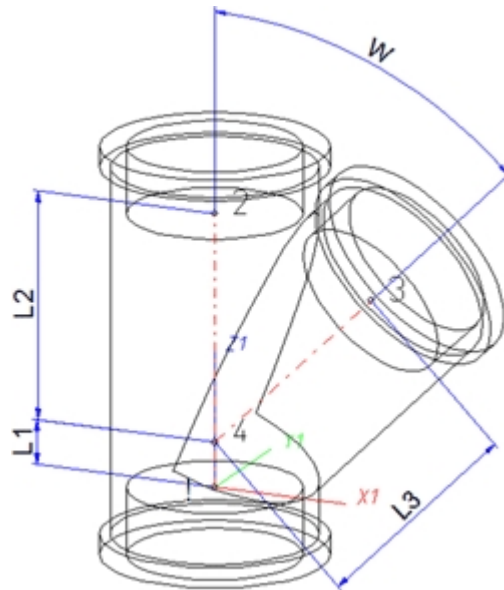

Position of connecting points and determination of insertion lengths for various connection types			
Connection for butt welding	Flange connection	Connecting nipple for screwed, plugged or socket-welded connection	Connecting socket for screwed, plugged or socket-welded connection
a = Insertion length dimension (e.g. L, L1 etc.)	a = Insertion length dimension (e.g. L, L1 etc.)	a = Insertion length dimension (e.g. L, L1 etc.)	a = Insertion length dimension (e.g. L, L1 etc.)

#### Named isolated points

Designation	Purpose	Comment	Position in coordinate system
!	Connecting point	Fitting point	in origin (0,0,0)
2	Connecting point		X = 0, Y = 0, Z > 0
3	Connecting point	on branch	X > 0, Y = 0, Z > 0
4	Auxiliary point	Branching point of centre line	X = 0, Y = 0, Z > 0

#### Variables names

Name	Description	Attribute (optional)
L1	Length of distance between points "!" und "4"	LAENGE1
L2	Length of distance between points "2" und "4"	LAENGE2
L3	Length of distance between points "3" und "4"	LAENGE3

If the variables names given in the **Name** column are used, you do not need to assign any attributes to them via the Variant Editor. If different variables are required, you need to assign the attributes given in the **Attribute** column.

### VAA file

Use the Variant Editor to enter the suitable part type into the VAA file.

Then, use the Variant Editor to expand the VAA file in such a way that it contains values for the sizes specified here, and that the predefined attribute assignment is entered.:

Parameter All dimensions must be specified in millimetres; Exception: Nominal diameters in inches	Variable (suggestion)	Assigned attribute
Nominal diameter, Connection “1”	N	NENNWEITE
Nominal diameter, Connection “2”	N2	NENNWEITE2
Nominal diameter, Connection “3”	N3	NENNWEITE3
Angle	W	WINKEL
<b>Additionally (only if the corresponding standard uses nominal diameters in inches):</b>		
Nominal diameter (inches), Connection “1”	NI	N_INCH
Nominal diameter (inches), Connection “2”	NI2	N2_INCH
Nominal diameter (inches), Connection “3”	NI3	N3_INCH
The nominal diameters in inches need to be entered as decimal values as well (e.g. 1.5 for 1 1/2”).		
<b>These parameters are to be considered for all connection types except for flange connections. For connecting sockets they refer to the pipe to be inserted:</b>		
Outer diameter, Connection “1”	D	D_AUSSEN
Outer diameter, Connection “2”	D2	D2_AUSSEN
Outer diameter, Connection “3”	D3	D3_AUSSEN
Wall thickness, Connection “1”	S	WANDDICKE
Wall thickness, Connection “2”	S2	WANDDICKE2
Wall thickness, Connection “3”	S3	WANDDICKE3

If required, the attributes LAENGE1, LAENGE2 and LAENGE3 need to be assigned to the length variables. (see Variables names above).

For variant synchronization you also need to enter the values for the attributes which are to apply to all sub-types of the variant.

Values must be entered for at least the following attributes:

Attribute	Description
BENENNUNG	Part designation
COMPONENT_TYPE	Part type (always = Semi-finished material + Plant Engineering) <u>for HELiOS database only</u>
NORMBEZEICHNUNG	Standard designation of the part (identical for all sub-types!) An entry is mandatory, even if the part corresponds to no standard.
ANSCHLUSSART	Connection type for Connection "1"
ANSCHLUSSART2	Connection type for Connection "2"
ANSCHLUSSART3	Connection type for Connection "3"
Possible values of the attribute ANSCHLUSSART (CONNECTION_TYPE):	
1000x	Butt-welded
2000x	Flange connection
2100x	Flange with groove connection
2200x	Flange with notch connection
2040x	Flange connection of a part that is not a flange itself. The part has a loose flange that is modelled as a sub-part and has no own article master attached to this connection.
3100x	Screwed, nipple
3200x	Screwed, socket
4100x	Plugged, nipple
4200x	Plugged, socket
5100x	Socket-welded, nipple
5200x	Socket-welded, socket
<p>The last character (x) provides information about the meaning of the supplement:  <b>0</b> = No supplement  <b>2</b> = The supplement consists of connection number, part type, ID, and standard of the part to be connected                      The prefixed connection number indicates the connection with which the auxiliary part is to be attached to the current connection.</p>	
<p> Please also read the information given in the paragraphs Connection type ID with priority information and Connection type ID - List of part standards.</p>	

 **Handling of nominal diameters in inches in the HELiOS database:**

During part data synchronization, nominal diameters in inches will be taken over to the attributes N\_INCH, N2\_INCH and N3\_. The usual character strings for indication of the diameter in inches (e.g. 1 1/2" instead of 1.5) will be auto-generated in the database for the attributes NPS\_INCH, NPS2\_INCH und NPS3\_INCH..

## Variant for Part Type: Valve

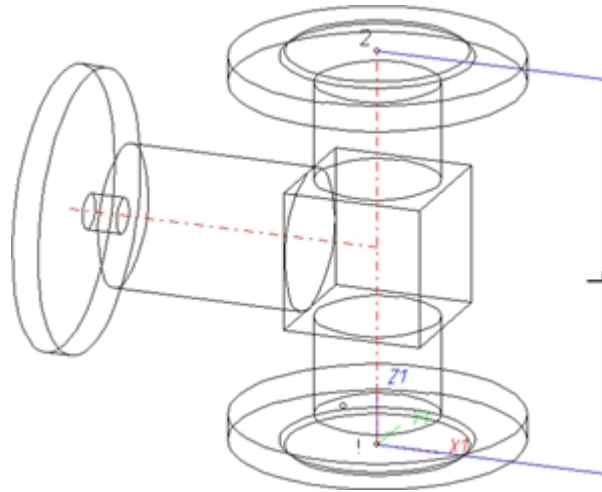

The centre axis of the actuator should be located in the plane  $X < 0, Y = 0, Z > 0$ .

Position of connecting points and determination of insertion lengths for various connection types			
Connection for butt welding	Flange connection	Connecting nipple for screwed, plugged or socket-welded connection	Connecting socket for screwed, plugged or socket-welded connection
a = Insertion length dimension (e.g. L, L1 etc.)	a = Insertion length dimension (e.g. L, L1 etc.)	a = Insertion length dimension (e.g. L, L1 etc.)	a = Insertion length dimension (e.g. L, L1 etc.)

### Named isolated points

Designation	Purpose	Comment	Position in coordinate system
!	Connecting point	Fitting point	in origin (0,0,0)
2	Connecting point		$X = 0, Y = 0, Z > 0$

### Variables names

Name	Description	Attribute (optional)
L	Distance between point "!" and "2"	LAENGE

If the variables names given in the **Name** column are used, you do not need to assign any attributes to them via the Variant Editor. If different variables are required, you need to assign the attributes given in the **Attribute** column.

### VAA file

Use the Variant Editor to enter the suitable part type into the VAA file.

Then, use the Variant Editor to expand the VAA file in such a way that it contains values for the sizes specified here, and that the predefined attribute assignment is entered:

Parameter	Variable (suggestion)	Assigned attribute
All dimensions must be specified in millimetres; Exception: Nominal diameters in inches		
Nominal diameter, Connection “1” and “2”	N	NENNWEITE
<b>Additionally (only if the corresponding standard uses nominal diameters in inches):</b>		
Nominal diameter (inches), Connection “1” and “2”	NI	N_INCH
Nominal diameters in inches need to be entered as decimal values as well (e.g. 1.5 for 1 1/2”).		
<b>These parameters are to be considered for all connection types except for flange connections. For connecting sockets they refer to the pipe to be inserted:</b>		
Outer diameter, Connection “1” and “2”	D	D_AUSSEN
Wall thickness, Connection “1” and “2”	S	WANDDICKE

If required, the attribute LAENGE need to be assigned to the length variables. (see Variables names above).

For variant synchronization you also need to enter the values for the attributes which are to apply to all sub-types of the variant.

Values must be entered for at least the following attributes:

Attribute	Description
BENENNUNG	Designation of part
COMPONENT_TYPE	Part type (always = Semi-finished material + Plant Engineering) <u>for HELIOS database only</u>
NORMBEZEICHNUNG	Standard designation of the part (identical for all sub-types!) An entry is mandatory, even if the part corresponds to no standard.
ANSCHLUSSART	Connection type for connection “1” and “2”
Possible values of the attribute ANSCHLUSSART (CONNECTION_TYPE):.	

Attribute	Description
1000x	Butt-welded
2000x	Flange connection
2100x	Flange with groove connection
2200x	Flange with notch connection
2040x	Flange connection of a part that is not a flange itself. The part has a loose flange that is modelled as a sub-part and has no own article master attached to this connection.
3100x	Screwed, nipple
3200x	Screwed, socket
4100x	Plugged, nipple
4200x	Plugged, socket
5100x	Socket-welded, nipple
5200x	Socket-welded, socket
<p>The last character (x) provides information about the meaning of the supplement:</p>	
<p><b>0</b>=No supplement</p>	
<p><b>2</b>= The supplement consists of connection number, part type, ID, and standard of the part to be connected</p>	
<p>The prefixed connection number indicates the connection with which the auxiliary part is to be attached to the current connection.</p>	
<p> Please also read the information given in the paragraphs Connection type ID with priority information and Connection type ID - List of part standards.</p>	

 **Handling of nominal diameters in inches in the HELiOs database:**

During part data synchronization, nominal diameters in inches will be taken over to the attributes N\_INCH, N2\_INCH and N3\_. The usual character strings for indication of the diameter in inches (e.g. 1 1/2" instead of 1.5) will be auto-generated in the database for the attributes NPS\_INCH, NPS2\_INCH und NPS3\_INCH.

## Variant for Part Type: Blank Flange

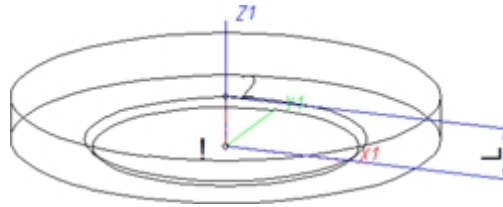

### Named isolated points

Designation	Purpose	Comment	Position in coordinate system
!	Connecting point	Fitting point	in origin (0,0,0)
2	Auxiliary point		X = 0, Y = 0, Z > 0

### Variables names

Name	Description	Attribute (optional)
L	Distance between points “!” and “2”	LAENGE

If the variables names given in the **Name** column are used, you do not need to assign any attributes to them via the Variant Editor. If different variables are required, you need to assign the attributes given in the **Attribute** column.

### VAA files

Use the Variant Editor to enter the suitable part type into the VAA file.

Then, use the Variant Editor to expand the VAA file in such a way that it contains values for the sizes specified here, and that the predefined attribute assignment is entered.

Parameter	Variable (suggestion)	Assigned attribute
All dimensions must be specified in millimetres; Exception: Nominal diameters in inches		
Nominal diameter, Connection “!”	N	NENNWEITE
<b>Additionally (only if the corresponding standard uses nominal diameters in inches):</b>		
Nominal diameter (inches), Connection “!”	NI	N_INCH
Nominal diameters in inches need to be entered as decimal values as well (e.g. 1.5 for 1 1/2“).		

If required, the attribute LAENGE need to be assigned to the length variables. (see Variables names above).

For variant synchronization you also need to enter the values for the attributes which are to apply to all sub-types of the variant.

Values must be entered for at least the following attributes:

Attribute	Description
BENENNUNG	Designation of the part
COMPONENT_TYPE	Part type (always = Semi-finished material + Plant Engineering) for HELIOS database only



Attribute	Description
NORMBEZEICHNUNG	Standard designation of the part (identical for all sub-types!) An entry is mandatory, even if the part corresponds to no standard.
ANSCHLUSSART	Connection type for connection "1" (always flange connection)
ANSCHLUSSART2	Connection type for connection "2" (always 0)
Possible values of the attribute ANSCHLUSSART (CONNECTION_TYPE):	
1000x	Butt-welded
2000x	Flange connection
2100x	Flange with groove connection
2200x	Flange with notch connection
3100x	Screwed, nipple
3200x	Screwed, socket
4100x	Plugged, nipple
4200x	Plugged, socket
5100x	Socket-welded, nipple
5200x	Socket-welded, socket
<p><b>Provide auxiliary part when fitting part</b></p> <p>If appropriately preset in the ANSCHLUSSART (CONNECTION_TYPE) attribute for a connection, the part will provide and connect an auxiliary part of the standard specified in the attribute for the connection when being fitted. For example, if the part has a flange connection and the corresponding counter-flange is required, the content of the ANSCHLUSSART (CONNECTION_TYPE) attribute could look as follows:  <b>20002 1 5100010 EN 1092-1/11/A/PN 40</b>  <b>EN 1092- 1/11/A/PN 40</b> is the standard designation with which the flange is to be entered into the database.</p> <p>The last character (x) provides information about the meaning of the supplement:  <b>0</b> = No supplement  <b>2</b> = The supplement consists of connection number, part type, ID, and standard of the part to be connected  The prefixed connection number indicates the connection with which the auxiliary part is to be attached to the current connection.</p>	
 Please also read the information given in the paragraphs Connection type ID with priority information and Connection type ID - List of part standards.	

 **Handling of nominal diameters in inches in the HELiOS database:**

During part data synchronization, nominal diameters in inches will be taken over to the attributes N\_INCH, N2\_INCH and N3\_. The usual character strings for indication of the diameter in inches (e.g. 1 1/2" instead of 1.5) will be auto-generated in the database for the attributes NPS\_INCH, NPS2\_INCH und NPS3\_INCH.

## Variant for Part Type: Double Knee

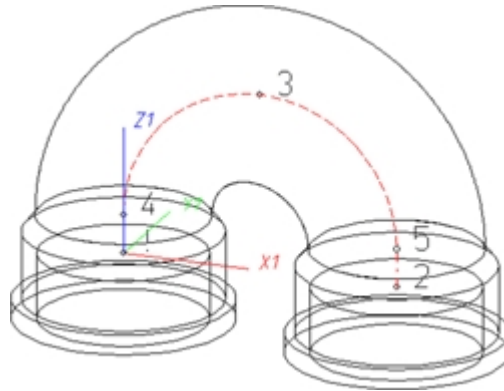

### Named isolated points

Designation	Purpose	Comment	Position in coordinate system
!	Connecting point	Fitting point	in origin (X1=0, Y1=0, Z1=0)
2	Connecting point		$X2 > 0, Y2 = 0, Z2 = 0$
3	Auxiliary point		$X3 = X2/2, Y3 = 0, Z3 > Z4$
4	Auxiliary point		$X4 = 0, Y4 = 0, Z4 > 0$
5	Auxiliary point		$X5 = X2, Y5 = 0, Z5 = Z4$

### VAA file

Use the Variant Editor to enter the suitable part type into the VAA file.

Then, use the Variant Editor to expand the VAA file in such a way that it contains values for the sizes specified here, and that the predefined attribute assignment is entered:

Parameter All dimensions must be specified in millimetres; Exception: Nominal diameters in inches	Variable (suggestion)	Assigned attribute
Nominal diameter, Connection "!" and "2"	N	NENNWEITE
<b>Additionally (only if the corresponding standard uses nominal diameters in inches):</b>		
Nominal diameter (inches), Connection "!" and "2"	NI	N_INCH
Nominal diameters in inches need to be entered as decimal values as well (e.g. 1.5 for 1 1/2").		
<b>These parameters are to be considered for all connection types except for flange connections. For connecting sockets they refer to the pipe to be inserted:</b>		
Outer diameter, Connection "!" and "2"	D	D_AUSSEN

Parameter	Variable (suggestion)	Assigned attribute
All dimensions must be specified in millimetres; Exception: Nominal diameters in inches		
Wall thickness, Connection “1” and “2”	S	WANDDICKE

If required, the attributes LAENGE1 and LAENGE2 need to be assigned to the length variables. (see Variables names above).

For variant synchronization you also need to enter the values for the attributes which are to apply to all sub-types of the variant.

Values must be entered for at least the following attributes:

Attribute	Description
BENENNUNG	Designation of the part
COMPONENT_TYPE	Part type (always = Semi-finished material + Plant Engineering) <u>for HELIOS database only</u>
NORMBEZEICHNUNG	Standard designation of the part (identical for all sub-types!) An entry is mandatory, even if the part corresponds to no standard.
ANSCHLUSSART	Connection type for connection “1”
ANSCHLUSSART2	Connection type for connection “2”

Possible values of the attribute ANSCHLUSSART (CONNECTION\_TYPE):

- 1000x Butt-welded
- 2000x Flange connection
- 2100x Flange with groove connection
- 2200x Flange with notch connection
- 2040x Flange connection of a part that is not a flange itself. The part has a loose flange that is modelled as a sub-part and has no own article master attached to this connection.
- 3100x Screwed, nipple
- 3200x Screwed, socket
- 4100x Plugged, nipple
- 4200x Plugged, socket
- 5100x Socket-welded, nipple
- 5200x Socket-welded, socket

**Provide auxiliary part when fitting part**

If appropriately preset in the ANSCHLUSSART (CONNECTION\_TYPE) attribute for a connection, the part will provide and connect an auxiliary part of the standard specified in the attribute for the connection when being fitted. For example, if the part has a flange connection and the corresponding counter-flange is required, the content of the ANSCHLUSSART (CONNECTION\_TYPE) attribute could look as follows:  
**20002 1 5100010 EN 1092-1/11/A/PN 40**  
**EN 1092-1/11/A/PN 40** is the standard designation with which the flange is to be entered into the database.

The last character (x) provides information about the meaning of the supplement:

**0**=No supplement

**2**= The supplement consists of connection number, part type, ID, and standard of the part to be connected

The prefixed connection number indicates the connection with which the auxiliary part is to be attached to the current connection.

Attribute	Description
	Please also read the information given in the paragraphs Connection type ID with priority information and Connection type ID - List of part standards.

 **Handling of nominal diameters in inches in the HELIOS database:**

During part data synchronization, nominal diameters in inches will be taken over to the attributes N\_INCH, N2\_INCH and N3\_. The usual character strings for indication of the diameter in inches (e.g. 1 1/2" instead of 1.5) will be auto-generated in the database for the attributes NPS\_INCH, NPS2\_INCH und NPS3\_INCH.

### Variant for Part Type: 3-Way Valve

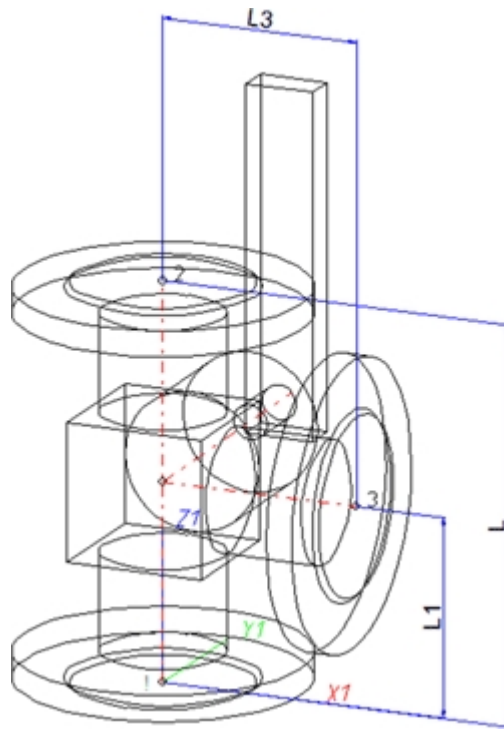

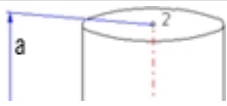
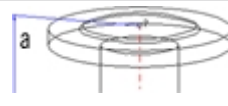
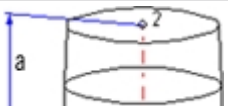
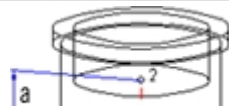
Position of connecting points and determination of insertion lengths for various connection types			
Connection for butt welding	Flange connection	Connecting nipple for screwed, plugged or socket-welded connection	Connecting socket for screwed, plugged or socket-welded connection
			
a = Insertion length dimension (e.g. L, L1 etc.)	a = Insertion length dimension (e.g. L, L1 etc.)	a = Insertion length dimension (e.g. L, L1 etc.)	a = Insertion length dimension (e.g. L, L1 etc.)

### Named isolated points

Designation	Purpose	Comment	Position in coordinate system
!	Connecting point	Fitting point	in origin (0,0,0)
2	Connecting point		X = 0, Y = 0, Z > 0
3	Connecting point	on branch	X > 0, Y = 0, Z > 0

### Variables names

Name	Description	Attribute (optional)
L	Length of distance between points “1” and “2”	LAENGE
L1	Length of distance between point “1” and branching point of centre line	LAENGE1
L3	Distance of point “3” from the line through “1” and “2”	LAENGE3

If the variables names given in the **Name** column are used, you do not need to assign any attributes to them via the Variant Editor. If different variables are required, you need to assign the attributes given in the **Attribute** column..

### VAA file

Use the Variant Editor to enter the suitable part type into the VAA file.

Then, use the Variant Editor to expand the VAA file in such a way that it contains values for the sizes specified here, and that the predefined attribute assignment is entered.

Parameter	Variable (suggestion)	Assigned attribute
All dimensions must be specified in millimetres; Exception: Nominal diameters in inches		
Nominal diameter, Connection “1” und “2”	N	NENNWEITE
Nominal diameter, Connection “3”	N3	NENNWEITE3
<b>Additionally (only if the corresponding standard uses nominal diameters in inches):</b>		
Nominal diameter (inches), Connection “1” and “2”	NI	N_INCH
Nominal diameter (inches), Connection “3”	NI3	N3_INCH
Nominal diameters in inches need to be entered as decimal values as well (e.g. 1.5 for 1 1/2”).		
<b>These parameters are to be considered for all connection types except for flange connections. For connecting sockets they refer to the pipe to be inserted:</b>		
Outer diameter, Connection “1” and “2”	D	D_AUSSEN
Outer diameter, Connection “3”	D3	D3_AUSSEN
Wall thickness, Connection “1” and “2”	S	WANDDICKE
Wall thickness, Connection “3”	S3	WANDDICKE3

If required, the attributes LAENGE, LAENGE1 and LAENGE3 need to be assigned to the length variables. (see Variables names above).

For variant synchronization you also need to enter the values for the attributes which are to apply to all sub-types of the variant.

Values must be entered for at least the following attributes:

Attribute	Description
BENENNUNG	Designation of part
COMPONENT_TYPE	Part type (always = Semi-finished material + Plant Engineering) <u>for HELIOS database only</u>
NORMBEZEICHNUNG	Standard designation of the part (identical for all sub-types!) An entry is mandatory, even if the part corresponds to no standard.
ANSCHLUSSART	Connection type for Connection "1", "2" und "3"
Possible values of the attribute ANSCHLUSSART (CONNECTION_TYPE):	
1000x	Butt-welded
2000x	Flange connection
2100x	Flange with groove connection
2200x	Flange with notch connection
2040x	Flange connection of a part that is not a flange itself. The part has a loose flange that is modelled as a sub-part and has no own article master attached to this connection.
3100x	Screwed, nipple
3200x	Screwed, socket
4100x	Plugged, nipple
4200x	Plugged, socket
5100x	Socket-welded, nipple
5200x	Socket-welded, socket
<p>The last character (x) provides information about the meaning of the supplement:  <b>0</b> = No supplement  <b>2</b> = The supplement consists of connection number, part type, ID, and standard of the part to be connected                      The prefixed connection number indicates the connection with which the auxiliary part is to be attached to the current connection.</p>	
<p> Please also read the information given in the paragraphs Connection type ID with priority information and Connection type ID - List of part standards.</p>	



**Handling of nominal diameters in inches in the HELIOS database:**

During part data synchronization, nominal diameters in inches will be taken over to the attributes N\_INCH, N2\_INCH and N3\_. The usual character strings for indication of the diameter in inches (e.g. 1 1/2" instead of 1.5) will be auto-generated in the database for the attributes NPS\_INCH, NPS2\_INCH und NPS3\_INCH.

### Variant for Part Type: Corner Valve

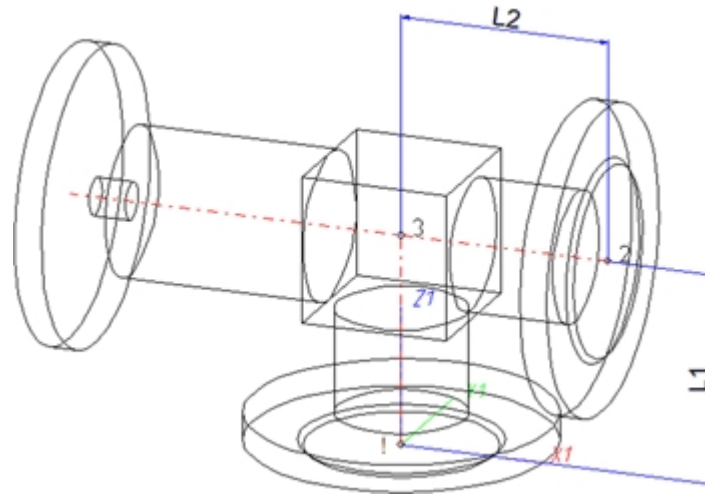

Position of connecting points and determination of insertion lengths for various connection types			
Connection for butt welding	Flange connection	Connecting nipple for screwed, plugged or socket-welded connection	Connecting socket for screwed, plugged or socket-welded connection
a = Insertion length dimension (e.g. L, L1 etc.)	a = Insertion length dimension (e.g. L, L1 etc.)	a = Insertion length dimension (e.g. L, L1 etc.)	a = Insertion length dimension (e.g. L, L1 etc.)

#### Named isolated points

Designation	Purpose	Comment	Position in coordinate system
!	Connecting point	Fitting point	in origin (0,0,0)
2	Connecting point		$X > 0, Y = 0, Z > 0$
3	Corner point		$X = 0, Y = 0, Z > 0$

#### Variables names

Name	Description	Attribute (optional)
L1	Distance between point "!" and "3"	LAENGE1
L2	Distance between point "3" and "2"	LAENGE2

If the variables names given in the **Name** column are used, you do not need to assign any attributes to them via the Variant Editor. If different variables are required, you need to assign the attributes given in the **Attribute** column.

#### VAA file



Use the Variant Editor to enter the suitable part type into the VAA file.

Then, use the Variant Editor to expand the VAA file in such a way that it contains values for the sizes specified here, and that the predefined attribute assignment is entered:

Parameter All dimensions must be specified in millimetres; Exception: Nominal diameters in inches	Variable (suggestion)	Assigned attribute
Nominal diameter, Connection “!”	N	NENNWEITE
Nominal diameter, Connection “2”	N2	NENNWEITE2
<b>Additionally (only if the corresponding standard uses nominal diameters in inches):</b>		
Nominal diameter (inches) , Connection “!”	NI	N_INCH
Nominal diameter (inches), Connection “2”	NI2	N2_INCH
Nominal diameters in inches need to be entered as decimal values as well (e.g. 1.5 for 1 1/2”).		
<b>These parameters are to be considered for all connection types except for flange connections. For connecting sockets they refer to the pipe to be inserted:</b>		
Outer diameter , Connection “!”	D	D_AUSSEN
Outer diameter , Connection “2”	D2	D2_AUSSEN
Wall thickness , Connection “!”	S	WANDDICKE
Wall thickness , Connection “2”	S2	WANDDICKE2

If required, the attributes LAENGE1 and LAENGE2 need to be assigned to the length variables. (see Variables names above).

For variant synchronization you also need to enter the values for the attributes which are to apply to all sub-types of the variant.

Values must be entered for at least the following attributes:

Attribute	Description
BENENNUNG	Designation of the part
COMPONENT_TYPE	Part type (always = Semi-finished products * Plant Engineering) <u>for HELiOS database only</u>
NORMBEZEICHNUNG	Standard designation of the part (identical for all sub-types!) An entry is mandatory, even if the part corresponds to no standard.
ANSCHLUSSART	Connection type for connection “!” and “2”
Possible values of the attribute ANSCHLUSSART (CONNECTION_TYPE):.	

Attribute		Description
1000x	Butt-welded	<p><b>Provide auxiliary part when fitting part</b></p> <p>If appropriately preset in the ANSCHLUSSART (CONNECTION_TYPE) attribute for a connection, the part will provide and connect an auxiliary part of the standard specified in the attribute for the connection when being fitted. For example, if the part has a flange connection and the corresponding counter-flange is required, the content of the ANSCHLUSSART (CONNECTION_TYPE) attribute could look as follows:  <b>20002 1 5100010 EN 1092-1/11/A/PN 40</b>  <b>EN 1092-1/11/A/PN 40</b> is the standard designation with which the flange is to be entered into the database.</p>
2000x	Flange connection	
2100x	Flange with groove connection	
2200x	Flange with notch connection	
2040x	Flange connection of a part that is not a flange itself. The part has a loose flange that is modelled as a sub-part and has no own article master attached to this connection.	
3100x	Screwed, nipple	
3200x	Screwed, socket	
4100x	Plugged, nipple	
4200x	Plugged, socket	
5100x	Socket-welded, nipple	
5200x	Socket-welded, socket	
<p>The last character (x) provides information about the meaning of the supplement:  <b>0</b>=No supplement  <b>2</b>= The supplement consists of connection number, part type, ID, and standard of the part to be connected                      The prefixed connection number indicates the connection with which the auxiliary part is to be attached to the current connection.</p>		
 <p>Please also read the information given in the paragraphs Connection type ID with priority information and Connection type ID - List of part standards.</p>		

 **Handling of nominal diameters in inches in the HELiOS database:**

During part data synchronization, nominal diameters in inches will be taken over to the attributes N\_INCH, N2\_INCH and N3\_. The usual character strings for indication of the diameter in inches (e.g. 1 1/2" instead of 1.5) will be auto-generated in the database for the attributes NPS\_INCH, NPS2\_INCH und NPS3\_INCH.

### Variant for Part Type: Flange

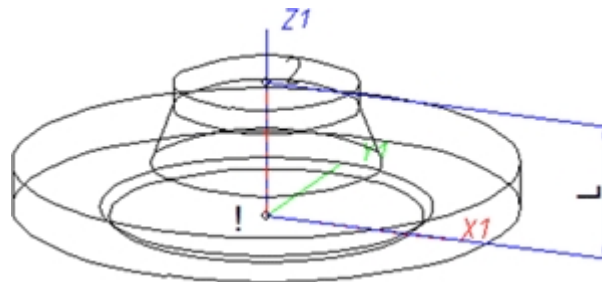

Position of connecting points and determination of insertion lengths for various connection types			
Connection for butt welding	Flange connection	Connecting nipple for screwed, plugged or socket-welded connection	Connecting socket for screwed, plugged or socket-welded connection
a = Insertion length dimension (e.g. L, L1 etc.)	a = Insertion length dimension (e.g. L, L1 etc.)	a = Insertion length dimension (e.g. L, L1 etc.)	a = Insertion length dimension (e.g. L, L1 etc.)

#### Named isolated points

Designation	Purpose	Comment	Position in coordinate system
!	Connecting point	Fitting point	in origin (0,0,0)
2	Connecting point		X = 0, Y = 0, Z > 0

#### Variables names

Name	Designation	Attribute (optional)
L	Distance between point "!" and "2"	LAENGE

If the variables names given in the **Name** column are used, you do not need to assign any attributes to them via the Variant Editor. If different variables are required, you need to assign the attributes given in the **Attribute** column...

#### VAA file

Use the Variant Editor to enter the suitable part type into the VAA file.

Then, use the Variant Editor to expand the VAA file in such a way that it contains values for the sizes specified here, and that the predefined attribute assignment is entered:

Parameter	Variable (suggestion)	Assigned attribute
All dimensions must be specified in millimetres; Exception: Nominal diameters in inches		
Nominal diameter, Connection "!" and "2"	N	NENNWEITE

Parameter All dimensions must be specified in millimetres; Exception: Nominal diameters in inches	Variable (suggestion)	Assigned attribute
<b>Additionally (only if the corresponding standard uses nominal diameters in inches):</b>		
Nominal diameter (inches), Connection “!” and “2“	NI	N_INCH
Nominal diameters in inches need to be entered as decimal values as well (e.g. 1.5 for 1 1/2“).		
<b>For connecting sockets these parameters refer to the pipe to be inserted:</b>		
Outer diameter , Connection “2“	D	D_AUSSEN
Wall thickness, Connection “2“	S	WANDDICKE

If required, the attribute LAENGE needs to be assigned to the length variables (see Variables names above).

For flangings, an additional variable **F1** is available, which determines the distance of the loose flange from connecting point 1 of the flanging. For flangings (welding necks, collar pieces etc) , F1 normally equals the wall thickness.

For variant synchronization you also need to enter the values for the attributes which are to apply to all sub-types of the variant.

Values must be entered for at least the following attributes:

Attribute	Description
BENENNUNG	Designation of the part
COMPONENT_TYPE	Part type (always = Semi-finished material + Plant Engineering) <u>for HELiOS database only</u>
NORMBEZEICHNUNG	Standard designation of the part (identical for all sub-types!) An entry is mandatory, even if the part corresponds to no standard.
ANSCHLUSSART	Connection type for connection “!” (always flange connection)
ANSCHLUSSART2	Connection type for connection “2“
Possible values of the attribute ANSCHLUSSART (CONNECTION_TYPE):.	

Attribute		Description
1000x	Butt-welded	<p><b>Provide auxiliary part when fitting part</b></p> <p>If appropriately preset in the ANSCHLUSSART (CONNECTION_TYPE) attribute for a connection, the part will provide and connect an auxiliary part of the standard specified in the attribute for the connection when being fitted. For example, if the part has a flange connection and the corresponding counter-flange is required, the content of the ANSCHLUSSART (CONNECTION_TYPE) attribute could look as follows:</p> <p><b>20002 1 5100010 EN 1092-1/11/A/PN 40</b></p> <p><b>EN 1092-1/11/A/PN 40</b> is the standard designation with which the flange is to be entered into the database.</p>
2000x	Flange connection	
2100x	Flange with groove connection	
2200x	Flange with notch connection	
2010x	Flange connection of a loose flange	
3100x	Screwed, nipple	
3200x	Screwed, socket	
4100x	Plugged, nipple	
4200x	Plugged, socket	
5100x	Socket-welded, nipple	
5200x	Socket-welded, socket	
<p>The last character (x) provides information about the meaning of the supplement:  <b>0</b> = No supplement  <b>2</b> = The supplement consists of connection number, part type, ID, and standard of the part to be connected                      The prefixed connection number indicates the connection with which the auxiliary part is to be attached to the current connection.</p>		
 <p>Please also read the information given in the paragraphs Connection type ID with priority information and Connection type ID - List of part standards.</p>		

 **Loose flanges** are assigned to the part type **Flange**. The attribute ANSCHLUSSART (=CONNECTION\_TYPE), however, must have the value 20100!

 **Handling of nominal diameters in inches in the HELiOS database:**

During part data synchronization, nominal diameters in inches will be taken over to the attributes N\_INCH, N2\_INCH and N3\_. The usual character strings for indication of the diameter in inches (e.g. 1 1/2" instead of 1.5) will be auto-generated in the database for the attributes NPS\_INCH, NPS2\_INCH und NPS3\_INCH.

### Model welding necks as flanges

As an alternative to the modelling of flangings as straight pipes, flangings can also be modelled as flanges if desired.

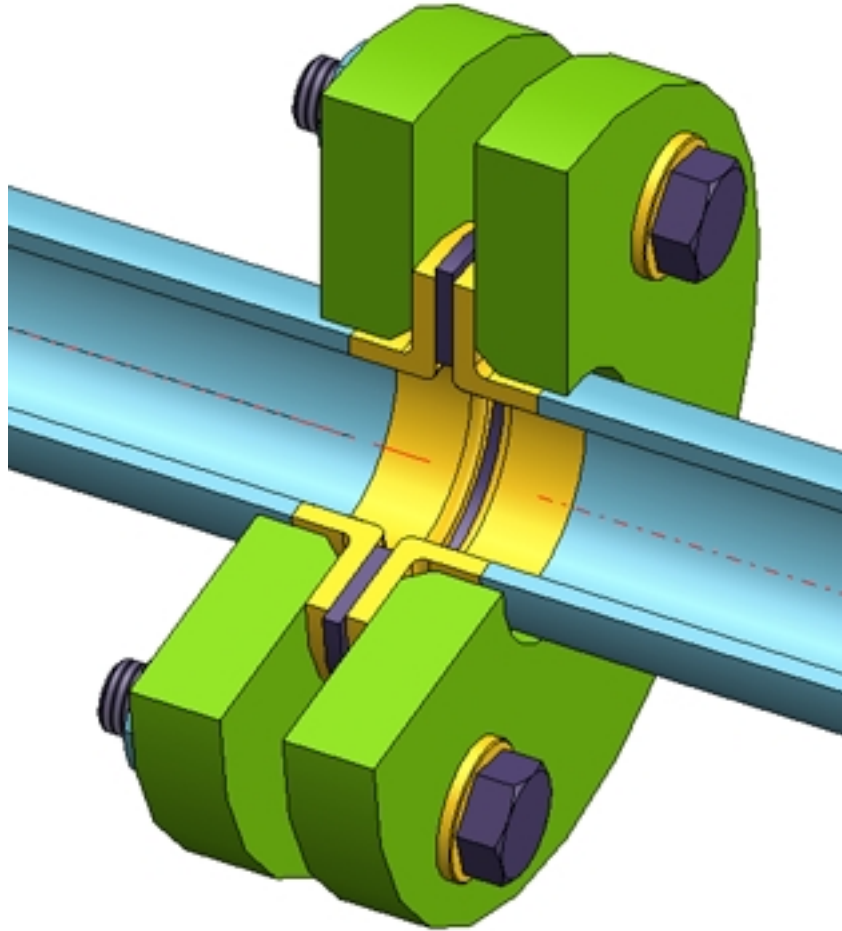

When using this procedure, the flanging must be of the type "Flange", while the loose flange is an asymmetrical fastener. The flange connection of the flanging must have the connection type 20600. The 6 coming in the third place encodes the asymmetrical fastener with flange connection, i.e. normally a loose flange classified as fastener. For this procedure the variable **F1** will also determine the distance of the loose flange to connecting point 1 of the flanging. For welding necks, F1 normally equals the wall thickness.

In contrast to flangings that are modelled as straight pipes, the flange symbol is assigned to the flanging here. This ensures that the position of the flange symbol in a generated isometry will not be affected by a possible moving of the loose flange.



**Please note:**

If you want to fix the loose flange by a welding point, you should not model it as a fastener, as fasteners do not support welding points on connecting points 2. In this case you must use genuine loose flanges, i.e. such flanges that are actually classified as flanges.

## Variant for Part Type: Straight Pipe

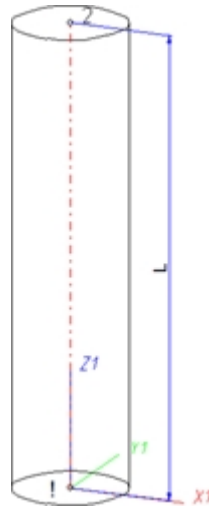

Position of connecting points and determination of insertion lengths for various connection types			
Connection for butt welding	Flange connection	Connecting nipple for screwed, plugged or socket-welded connection	Connecting socket for screwed, plugged or socket-welded connection
a = Insertion length dimension (e.g. L, L1 etc.)	a = Insertion length dimension (e.g. L, L1 etc.)	a = Insertion length dimension (e.g. L, L1 etc.)	a = Insertion length dimension (e.g. L, L1 etc.)

### Named isolated points

Designation	Purpose	Comment	Position in coordinate system
!	Connecting point	Fitting point	In origin (0,0,0)
2	Connecting point		X = 0, Y = 0, Z > 0

### Variables names

Name	Description	Attribute (optional)
L	Distance between point "!" and "2"	LAENGE

If the variables names given in the **Name** column are used, you do not need to assign any attributes to them via the Variant Editor. If different variables are required, you need to assign the attributes given in the **Attribute** column.

### VAA file

Use the Variant Editor to enter the suitable part type into the VAA file.

Then, use the Variant Editor to expand the VAA file in such a way that it contains values for the sizes specified here, and that the predefined attribute assignment is entered:

Parameter All dimensions must be specified in millimetres; Exception: Nominal diameters in inches	Variable (suggestion)	Assigned attribute
Nominal width, Connection “1” and “2”	N	NENNWEITE
Length (if a cutting to length of the pipe is permissible, the value is arbitrary. The length needs however to be smaller than the supplied length.)	L	LAENGE
<b>Additionally (only if the corresponding standard uses nominal diameters in inches):</b>		
Nominal diameter (inches) , Connection “1” and “2”	NI	N_INCH
Nominal diameters in inches need to be entered as decimal values as well (e.g. 1.5 for 1 1/2”).		
<b>These parameters are to be considered for all connection types except for flange connections. For connecting sockets they refer to the pipe to be inserted:</b>		
Outer diameter, Connection “1” and “2”	D	D_AUSSEN
Wall thickness, Connection “1” and “2”	S	WANDDICKE

If required, the attribute LAENGE needs to be assigned to the length variables (see Variables names above).

For flangings, the additional variables **F1** and **F2** are available, for the distance of the loose flange to the flanging edge.



For variant synchronization you also need to enter the values for the attributes which are to apply to all sub-types of the variant.

Values must be entered for at least the following attributes:

Attribute	Description
BENENNUNG	Designation of the part
COMPONENT_TYPE	Part type (always = Semi-finished material + Plant Engineering) <u>for HELiOS data-base only</u>
NORMBEZEICHNUNG	Standard designation of the part (identical for all sub-types!) An entry is mandatory, even if the part corresponds to no standard.
BELIEBIG_TEILBAR	Indicates whether the cutting to length of the pipe, is permissible.
LIEFERLAENGE	Supplied length in m (!)
ANSCHLUSSART  ANSCHLUSSART2	<p>Connection type for connection “!” and “2“</p> <p>If you want both pipe ends to have the same connection type it will suffice to specify a value for the ANSCHLUSSART attribute.</p> <p>If you want the two pipe ends to have different connection types, the connection type for Connection 1 must be specified for the ANSCHLUSSART attribute, and the connection type for Connection 2 for the ANSCHLUSSART2 attribute.</p> <p>If you want to create a new feature variant of a straight pipe with different connection types, the part must be constructed in such a way that the value of the attribute ANSCHLUSSART is smaller than the value of the attribute ANSCHLUSSART2.</p> <p><b>Example:</b></p> <p>Let us assume that you require a pipe that can be butt-welded at one end, and has a screwed socket at the other end.</p> <p>The connection type for butt-welded connections is 10000, the one for screwed sockets is 32000. This means that Connection 1 (Point designation “!”) is required for the welded connection (ANSCHLUSSART = 10000) and Connection 2 (point designation “2”) is required for the screwed connection (ANSCHLUSSART2 = 32000).</p>
Possible values of the attribute ANSCHLUSSART (CONNECTION_TYPE) and ANSCHLUSSART2 (CONNECTION_TYPE2):	

Attribute	Description
1000x	Butt-welded
2000x	Flange connection
2100x	Flange with groove connection
2200x	Flange with notch connection
2040x	Flange connection of a part that is not a flange itself. The part has a loose flange that is modelled as a sub-part and has no own article master attached to this connection.
3100x	Screwed, nipple
3200x	Screwed, socket
4100x	Plugged, nipple
4200x	Plugged, socket
5100x	Socket-welded, nipple
5200x	Socket-welded, socket

**Provide auxiliary part when fitting part**  
 If appropriately preset in the ANSCHLUSSART (CONNECTION\_TYPE) attribute for a connection, the part will provide and connect an auxiliary part of the standard specified in the attribute for the connection when being fitted. For example, if the part has a flange connection and the corresponding counter-flange is required, the content of the ANSCHLUSSART (CONNECTION\_TYPE) attribute could look as follows:  
**20002 1 5100010 EN 1092-1/11/A/PN 40**  
**EN 1092-1/11/A/PN 40** is the standard designation with which the flange is to be entered into the database.

The last character (x) provides information about the meaning of the supplement:  
**0**=No supplement  
**2**=The supplement consists of connection number, part type, ID, and standard of the part to be connected  
 The prefixed connection number indicates the connection with which the auxiliary part is to be attached to the current connection.

 Please also read the information given in the paragraphs Connection type ID with priority information and Connection type ID - List of part standards.



**Important:**

- When working with the **HELIOS database**, please pay attention to the correct classification matching the part type.
- During variant synchronization the **Nominal diameters in inches** will initially only be taken over into the attribute N\_INCH in the form of decimal numbers. The usual character strings for the specification of the nominal diameter in inches (e.g. 1 1/2" instead of 1.5) can be subsequently generated in the HELIOS database for the attribute NPS\_INCH. For this purpose the HiCAD macro ANLDB\_ZOLLATTRIGEN.MAC in the \HICAD\MAKROANL folder is used.
- Please also read the information about pipe-dependent placing of loose flanges given below!

### Model collar pieces as straight pipes

Loose flanges can be placed manually or automatically on the connecting point of straight pipes. In the process, the first connecting point of the loose flange will be placed on the connecting point of the straight pipe. Sometimes, however, it is desirable to move the representation of the loose flange slightly away from the connecting point, e.g. in cases where the straight pipe ends with a flanged edge which is not to be overlapped by the geometry of the loose flange.

To achieve this, you can define a suitable distance in the feature variables of the straight pipe. This distance must be stored in the Variable F1 for the first connecting point, and in the Variable F2 for the second connecting point.

Even if the end of the pipe is just a flanged end, the required connection type will be 10000 (welded connection).  
The result will look as follows:

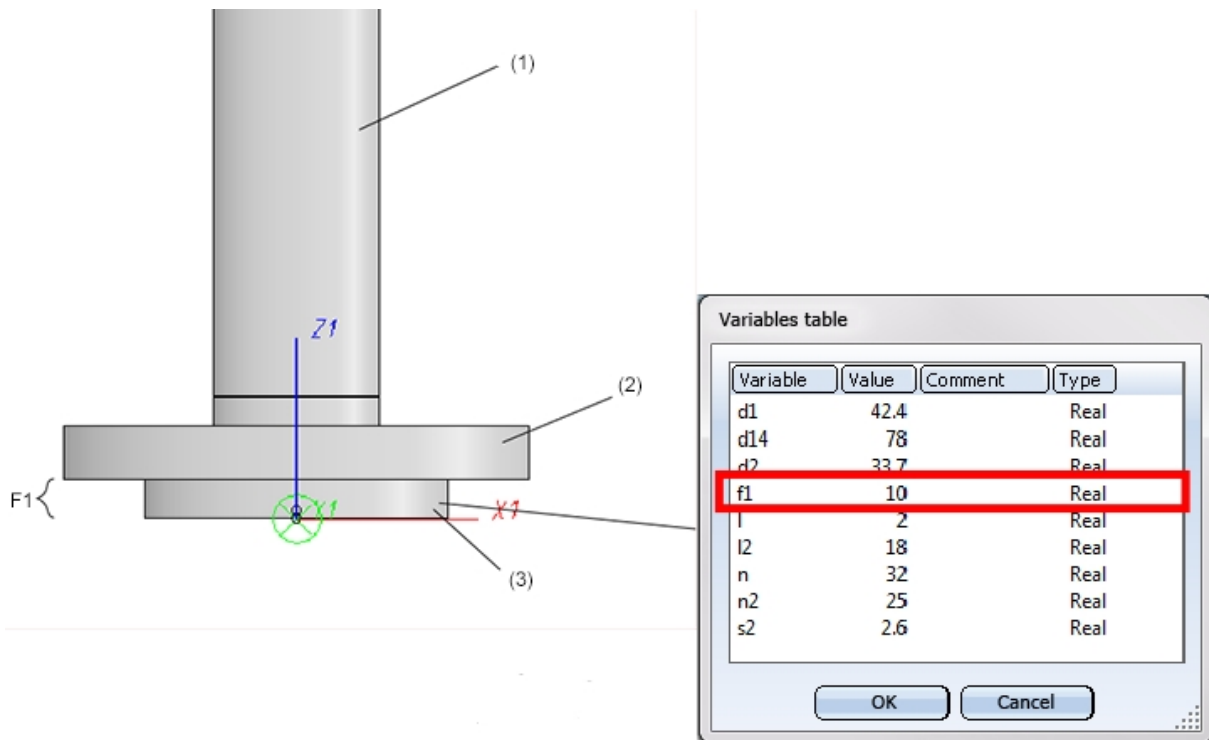

(1) Straight pipe, (2) Loose flange, (3) Collar piece, modelled as straight pipe defining a distance of the loose flange via F1 for the first connecting point.

After insertion of the loose flange, its first connecting point will still be located at the end of the straight pipe, but the part geometry and the second connecting point have been moved away from the connection by the value F1.



**Please note:**

- The modelling of flangings such as collar pieces as straight pipes is not optimal if you want to create an isometry of the pipeline, as the flange symbol of the loose flange will then be slightly displaced. Alternatively, you have the option to model flangings as straight pipes, so that the flange symbol is assigned to the flanging. This ensures that the position of the flange symbol in a generated isometry will not be affected by a possible moving of the loose flange.
- During manual placing of loose flanges, please bear in mind that the Guideline mode must be switched off, and that **Connection 1 on target connection** must have been selected during insertion.

### Variant for Part Type: Y-Piece

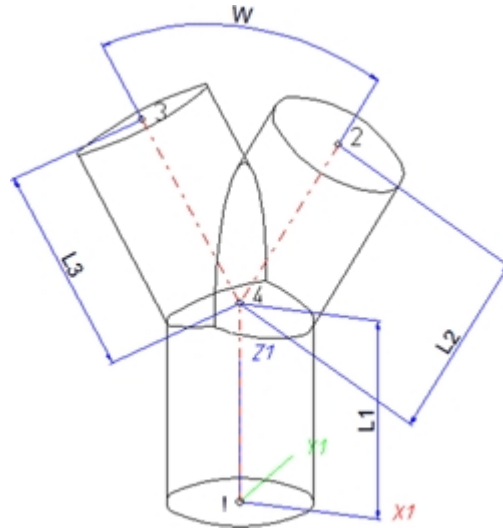

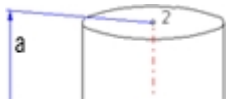
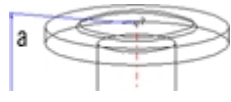
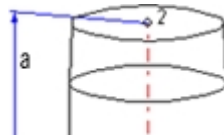
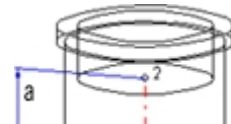
Position of connecting points and determination of insertion lengths for various connection types			
Connection for butt welding	Flange connection	Connecting nipple for screwed, plugged or socket-welded connection	Connecting socket for screwed, plugged or socket-welded connection
			
a = Insertion length dimension (e.g. L, L1 etc.)	a = Insertion length dimension (e.g. L, L1 etc.)	a = Insertion length dimension (e.g. L, L1 etc.)	a = Insertion length dimension (e.g. L, L1 etc.)

### Named isolated points

Designation	Purpose	Comment	Position in coordinate system
!	Connecting point	Fitting point	in origin (0,0,0)
2	Connecting point		$X > 0, Y = 0, Z > 0$
3	Connecting point		$X < 0, Y = 0, Z > 0$
4	Auxiliary point		$X = 0, Y = 0, Z > 0$

### Variables names

Name	Description	Attribute (optional)
L1	Distance between point "!" and "4"	LAENGE1
L2	Distance between point "2" and "4"	LAENGE2
L3	Distance between point "3" and "4"	LAENGE3

If the variables names given in the **Name** column are used, you do not need to assign any attributes to them via the Variant Editor. If different variables are required, you need to assign the attributes given in the **Attribute** column.

### VAA file

Use the Variant Editor to enter the suitable part type into the VAA file.

Then, use the Variant Editor to expand the VAA file in such a way that it contains values for the sizes specified here, and that the predefined attribute assignment is entered:

Parameter All dimensions must be specified in millimetres; Exception: Nominal diameters in inches	Variable (suggestion)	Assigned attribute
Nominal diameter, Connection “!”	N	NENNWEITE
Nominal diameter, Connection “2” and “3”	N2	NENNWEITE2
Angle	W	WINKEL
<b>Additionally (only if the corresponding standard uses nominal diameters in inches):</b>		
Nominal diameter (inches), Connection “!”	NI	N_INCH
Nominal diameter (inches), Connection “2” and “3”	NI2	N2_INCH
As only decimal values are saved to the VAA file as parameter values, nominal diameters in inches need to be entered as decimal values as well (e.g. 1.5 for 1 1/2“).		
<b>These parameters are to be considered for all connection types except for flange connections. For connecting sockets they refer to the pipe to be inserted:</b>		
Outer diameter, Connection “!”	D	D_AUSSEN
Outer diameter, Connection “2” und “3”	D2	D2_AUSSEN
Wall diameter, Connection “!”	S	WANDDICKE
Wall diameter, Connection “2” and “3”	S2	WANDDICKE2

If required, the attributes LAENGE1, LAENGE2 and LAENGE3 need to be assigned to the length variables (see Variables names above).

For variant synchronization you also need to enter the values for the attributes which are to apply to all sub-types of the variant.

Values must be entered for at least the following attributes:

Attribute	Description
BENENNUNG	Designation of part
COMPONENT_TYPE	Part type (always = Semi-finished material + Plant Engineering) <u>for HELIOS database only</u>
NORMBEZEICHNUNG	Standard designation of the part (identical for all sub-types!) An entry is mandatory, even if the part corresponds to no standard.
ANSCHLUSSART	Connection type for connection "1"
ANSCHLUSSART2	Connection type for connection "2" and "3"

Possible values of the attribute ANSCHLUSSART (CONNECTION\_TYPE):

1000x	Butt-welded
2000x	Flange connection
2100x	Flange with groove connection
2200x	Flange with notch connection
2040x	Flange connection of a part that is not a flange itself. The part has a loose flange that is modelled as a sub-part and has no own article master attached to this connection.
3100x	Screwed, nipple
3200x	Screwed, socket
4100x	Plugged, nipple
4200x	Plugged, socket
5100x	Socket-welded, nipple
5200x	Socket-welded, socket

**Provide auxiliary part when fitting part**

If appropriately preset in the ANSCHLUSSART (CONNECTION\_TYPE) attribute for a connection, the part will provide and connect an auxiliary part of the standard specified in the attribute for the connection when being fitted. For example, if the part has a flange connection and the corresponding counter-flange is required, the content of the ANSCHLUSSART (CONNECTION\_TYPE) attribute could look as follows:

**20002 1 5100010 EN 1092-1/11/A/PN 40**

**EN 1092-1/11/A/PN 40** is the standard designation with which the flange is to be entered into the database.

The last character (x) provides information about the meaning of the supplement:

**0** = No supplement

**2** = The supplement consists of connection number, part type, ID, and standard of the part to be connected

The prefixed connection number indicates the connection with which the auxiliary part is to be attached to the current connection.



Please also read the information given in the paragraphs Connection type ID with priority information and Connection type ID - List of part standards.



**Handling of nominal diameters in inches in the HELIOS database:**

During part data synchronization, nominal diameters in inches will be taken over to the attributes N\_INCH, N2\_INCH and N3\_. The usual character strings for indication of the diameter in inches (e.g. 1 1/2" instead of 1.5) will be auto-generated in the database for the attributes NPS\_INCH, NPS2\_INCH und NPS3\_INCH.

## Variant for Part Type: Cap

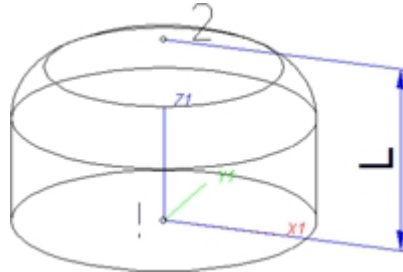

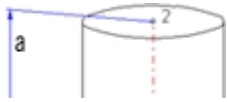
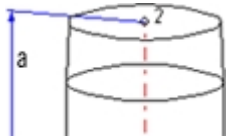
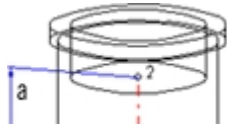
Position of connecting points and determination of insertion lengths for various connection types		
Connection for butt welding	Connecting nipple for screwed, plugged or socket-welded connection	Connecting socket for screwed, plugged or socket-welded connection
		
a = Insertion length dimension (e.g. L, L1 etc.)	a = Insertion length dimension (e.g. L, L1 etc.)	a = Insertion length dimension (e.g. L, L1 etc.)

### Named isolated points

Designation	Purpose	Comment	Position in coordinate system
!	Connecting point	Fitting point	in origin (0,0,0)
2	Auxiliary point		X = 0, Y = 0, Z > 0

### Variables names

Name	Designation	Attribute (optional)
L	Distance between point “!” and “2”	LAENGE

If the variables names given in the **Name** column are used, you do not need to assign any attributes to them via the Variant Editor. If different variables are required, you need to assign the attributes given in the **Attribute** column..

### VAA file

Use the Variant Editor to enter the suitable part type into the VAA file.

Then, use the Variant Editor to expand the VAA file in such a way that it contains values for the sizes specified here, and that the predefined attribute assignment is entered:

Parameter	Variable (suggestion)	Assigned attribute
All dimensions must be specified in millimetres; Exception: Nominal diameters in inches		
Nominal diameter, Connection “!”	N	NENNWEITE
Outer diameter, Connection “!”	D	D_AUSSEN

Parameter	Variable (suggestion)	Assigned attribute
All dimensions must be specified in millimetres; Exception: Nominal diameters in inches		
Wall thickness, Connection “!”	S	WANDDICKE
<b>Additionally (only if the corresponding standard uses nominal diameters in inches):</b>		
Nominal diameter (inches), Connection “!”	NI	N_INCH
Nominal diameters in inches need to be entered as decimal values as well (e.g. 1.5 for 1 1/2“).		

If required, the attribute LAENGE needs to be assigned to the length variables. (see Variables names above).

For variant synchronization you also need to enter the values for the attributes which are to apply to all sub-types of the variant.

Values must be entered for at least the following attributes:

Attribute	Description
BENENNUNG	Designation of part
COMPONENT_TYPE	Part type (always = Semi-finished material + Plant Engineering) <u>for HELIOS database only</u>
NORMBEZEICHNUNG	Standard designation of the part (identical for all sub-types!) An entry is mandatory, even if the part corresponds to no standard.
ANSCHLUSSART	Connection type for connection “!”
Possible values of the attribute ANSCHLUSSART (CONNECTION_TYPE):.	
1000x	Butt-welded
2000x	Flange connection
2100x	Flange with groove connection
2200x	Flange with notch connection
2040x	Flange connection of a part that is not a flange itself. The part has a loose flange that is modelled as a sub-part and has no own article master attached to this connection.
3100x	Screwed, nipple
3200x	Screwed, socket
4100x	Plugged, nipple
4200x	Plugged, socket
5100x	Socket-welded, nipple
5200x	Socket-welded, socket
<p><b>Provide auxiliary part when fitting part</b></p> <p>If appropriately preset in the ANSCHLUSSART (CONNECTION_TYPE) attribute for a connection, the part will provide and connect an auxiliary part of the standard specified in the attribute for the connection when being fitted. For example, if the part has a flange connection and the corresponding counter-flange is required, the content of the ANSCHLUSSART (CONNECTION_TYPE) attribute could look as follows:  <b>20002 1 5100010 EN 1092-1/11/A/PN 40</b>  <b>EN 1092-1/11/A/PN 40</b> is the standard designation with which the flange is to be entered into the database.</p>	
<p>The last character (x) provides information about the meaning of the supplement:  <b>0</b>=No supplement  <b>2</b>= The supplement consists of connection number, part type, ID, and standard of the part to be connected                      The prefixed connection number indicates the connection with which the auxiliary part is to be attached to the current connection.</p>	



Attribute	Description
	Please also read the information given in the paragraphs Connection type ID with priority information and Connection type ID - List of part standards.

**Handling of nominal diameters in inches in the HELIOS database:**

During part data synchronization, nominal diameters in inches will be taken over to the attributes N\_INCH, N2\_INCH and N3\_. The usual character strings for indication of the diameter in inches (e.g. 1 1/2" instead of 1.5) will be auto-generated in the database for the attributes NPS\_INCH, NPS2\_INCH und NPS3\_INCH.

## Variant for Part Type: Knee

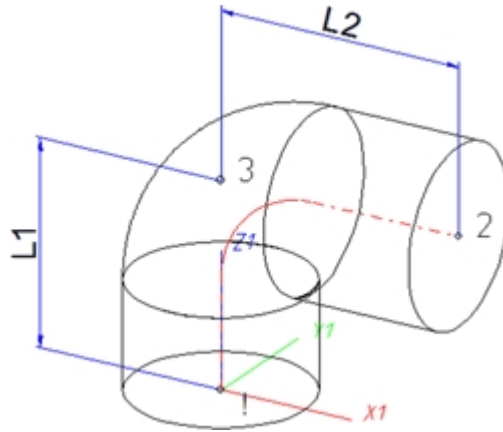

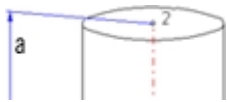
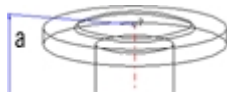
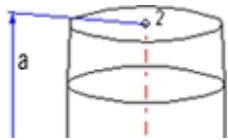
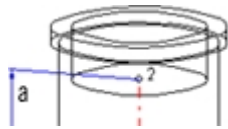
Position of connecting points and determination of insertion lengths for various connection types			
Connection for butt welding	Flange connection	Connecting nipple for screwed, plugged or socket-welded connection	Connecting socket for screwed, plugged or socket-welded connection
			
a = Insertion length dimension (e.g. L, L1 etc.)	a = Insertion length dimension (e.g. L, L1 etc.)	a = Insertion length dimension (e.g. L, L1 etc.)	a = Insertion length dimension (e.g. L, L1 etc.)

### Named isolated points

Designation	Purpose	Comment	Position in coordinate system
!	Connecting point	Fitting point	in origin (0,0,0)
2	Connecting point		$X > 0, Y = 0, Z > 0$
3	Corner point		$X = 0, Y = 0, Z > 0$

### Variables names

Name	Description	Attribute (optional)
L1	Distance between point “!” and “3”	LAENGE1
L2	Distance between point “3” and “2”	LAENGE2

If the variables names given in the **Name** column are used, you do not need to assign any attributes to them via the Variant Editor. If different variables are required, you need to assign the attributes given in the **Attribute** column..

### VAA file

Use the Variant Editor to enter the suitable part type into the VAA file.

Then, use the Variant Editor to expand the VAA file in such a way that it contains values for the sizes specified here, and that the predefined attribute assignment is entered.:

Parameter All dimensions must be specified in mil- limetres; Exception: Nominal diameters in inches	Variable (suggestion)	Assigned attribute
Nominal diameter, Connection “1”	N	NENNWEITE
Nominal diameter, Connection “2”	N2	NENNWEITE2
Angles between the distances “3” - > “1” and “3” ->“2”	W	WINKEL
<b>Additionally (only if the corresponding standard uses nominal diameters in inches):</b>		
Nominal diameter (inches), Con- nection “1”	NI	N_INCH
Nominal diameter (inches), Con- nection “2”	NI2	N2_INCH
Nominal diameters in inches need to be entered as decimal values as well (e.g. 1.5 for 1 1/2”).		
<b>These parameters are to be considered for all connection types except for flange connections. For con- necting sockets they refer to the pipe to be inserted:</b>		
Outer diameter , Connection “1”	D	D_AUSSEN
Outer diameter, Connection “2”	D2	D2_AUSSEN
Wall thickness, Connection “1”	S	WANDDICKE
Wall thickness, Connection “2”	S2	WANDDICKE2

If required, the attributes LAENGE1 and LAENGE2 need to be assigned to the length variables. (see Variables names above).

For variant synchronization you also need to enter the values for the attributes which are to apply to all sub-types of the variant.

Values must be entered for at least the following attributes:

Attribute	Description
BENENNUNG	Designation of part
COMPONENT_TYPE	Part type (always = Semi-finished material + Plant Engineering) <u>for HELIOS database only</u>
NORMBEZEICHNUNG	Standard designation of the part (identical for all sub-types!) An entry is mandatory, even if the part corresponds to no standard.
ANSCHLUSSART	Connection type for Connection "1"
ANSCHLUSSART2	Connection type for Connection "2"

Possible values of the attribute ANSCHLUSSART (CONNECTION\_TYPE):

- 1000x Butt-welded
- 2000x Flange connection
- 2100x Flange with groove connection
- 2200x Flange with notch connection
- 2040x Flange connection of a part that is not a flange itself. The part has a loose flange that is modelled as a sub-part and has no own article master attached to this connection.
- 3100x Screwed, nipple
- 3200x Screwed, socket
- 4100x Plugged, nipple
- 4200x Plugged, socket
- 5100x Socket-welded, nipple
- 5200x Socket-welded, socket

**Provide auxiliary part when fitting part**

If appropriately preset in the ANSCHLUSSART (CONNECTION\_TYPE) attribute for a connection, the part will provide and connect an auxiliary part of the standard specified in the attribute for the connection when being fitted. For example, if the part has a flange connection and the corresponding counter-flange is required, the content of the ANSCHLUSSART (CONNECTION\_TYPE) attribute could look as follows:  
**20002 1 5100010 EN 1092-1/11/A/PN 40**  
**EN 1092-1/11/A/PN 40** is the standard designation with which the flange is to be entered into the database.

The last character (x) provides information about the meaning of the supplement:

**0**=No supplement

**2**= The supplement consists of connection number, part type, ID, and standard of the part to be connected

The prefixed connection number indicates the connection with which the auxiliary part is to be attached to the current connection.



Please also read the information given in the paragraphs Connection type ID with priority information and Connection type ID - List of part standards.



**Handling of nominal diameters in inches in the HELIOS database:**

During part data synchronization, nominal diameters in inches will be taken over to the attributes N\_INCH, N2\_INCH and N3\_. The usual character strings for indication of the diameter in inches (e.g. 1 1/2" instead of 1.5) will be auto-generated in the database for the attributes NPS\_INCH, NPS2\_INCH und NPS3\_INCH.

### Variant for Part Type: Cross

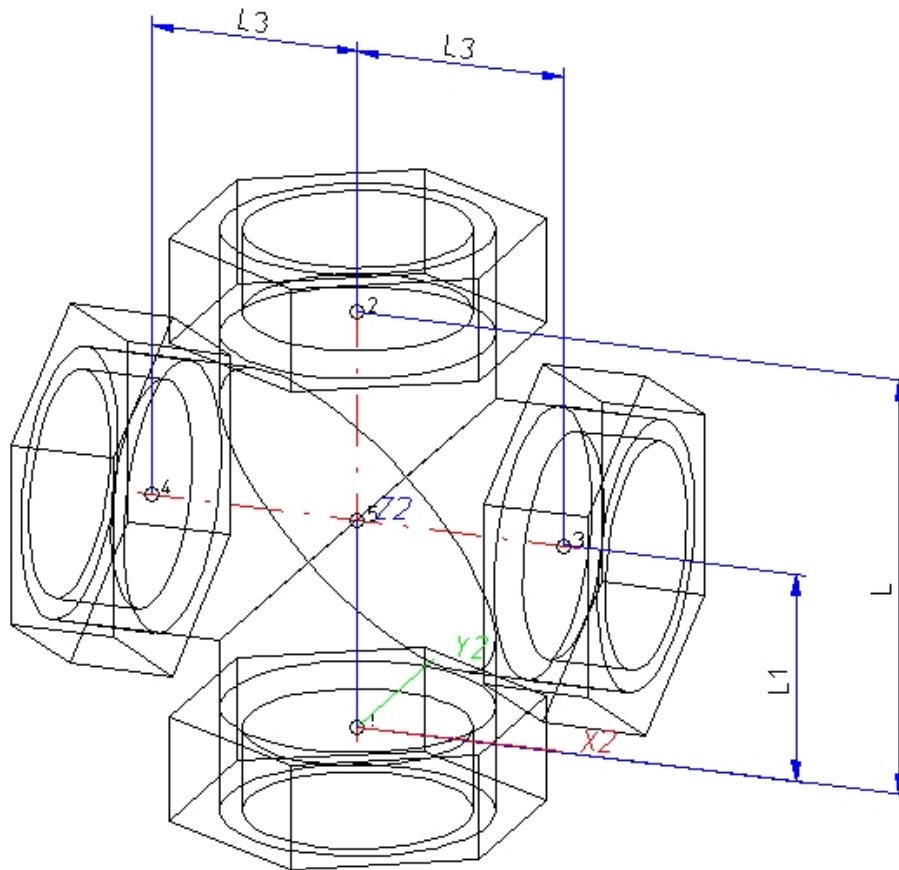

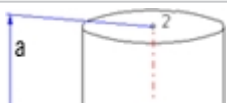
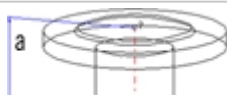
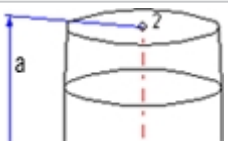
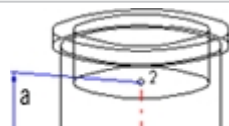
Position of connecting points and determination of insertion lengths for various connection types			
Connection for butt welding	Flange connection	Connecting nipple for screwed, plugged or socket-welded connection	Connecting socket for screwed, plugged or socket-welded connection
			
a = Insertion length dimension (e.g. L, L1 etc.)	a = Insertion length dimension (e.g. L, L1 etc.)	a = Insertion length dimension (e.g. L, L1 etc.)	a = Insertion length dimension (e.g. L, L1 etc.)

### Named isolated points

Designation	Purpose	Comment	Position in coordinate system
!	Connecting point	Fitting point	in origin (0,0,0)
2	Connecting point		X = 0, Y = 0, Z > 0
3	Connecting point	on branch	X > 0, Y = 0, Z > 0
4	Connecting point	on branch	X <= 0, Y = 0, Z > 0

### Variables names

Name	Description	Attribute (optional)
L	Distance between point "!" and "2"	LAENGE
L1	Distance between point "!" and the intersection point of the centre lines	LAENGE1
L3	Distance between point "3" and "4"	LAENGE3

If the variables names given in the **Name** column are used, you do not need to assign any attributes to them via the Variant Editor. If different variables are required, you need to assign the attributes given in the **Attribute** column..

### VAA file

Use the Variant Editor to enter the suitable part type into the VAA file.

Then, use the Variant Editor to expand the VAA file in such a way that it contains values for the sizes specified here, and that the predefined attribute assignment is entered.:

Parameter All dimensions must be specified in mil- limetres; Exception: Nominal diameters in inches	Variable (suggestion)	Assigned attribute
Nominal diameter, Connection "!" and "2"	N	NENNWEITE
Nominal diameter, Connection "3" and "4"	N3	NENNWEITE3
<b>Additionally (only if the corresponding standard uses nominal diameters in inches):</b>		
Nominal diameter (inches), Con- nection "!" and "2"	NI	N_INCH
Nominal diameter (inches), Con- nection "3" and "4"	NI3	N3_INCH
Nominal diameters in inches need to be entered as decimal values as well (e.g. 1.5 for 1 1/2").		
<b>These parameters are to be considered for all connection types except for flange connections. For con- necting sockets they refer to the pipe to be inserted:</b>		
Outer diameter , Connection "!" and "2"	D	D_AUSSEN
Outer diameter, Connection "3" and "4"	D3	D3_AUSSEN
Wall thickness, Connection "!" and "2"	S	WANDDICKE

Parameter All dimensions must be specified in millimetres; Exception: Nominal diameters in inches	Variable (suggestion)	Assigned attribute
Wall thickness, Connection "3" and "4"	S3	WANDDICKE3

If required, the attributes LAENGE, LAENGE1 and LAENGE3 need to be assigned to the length variables. (see Variables names above).

For variant synchronization you also need to enter the values for the attributes which are to apply to all sub-types of the variant.

Values must be entered for at least the following attributes:

Attribute	Description
BENENNUNG	Designation of part
COMPONENT_TYPE	Part type (always = Semi-finished material + Plant Engineering) <u>for HELIOS database only</u>
NORMBEZEICHNUNG	Standard designation of the part (identical for all sub-types!) An entry is mandatory, even if the part corresponds to no standard.
ANSCHLUSSART	Connection type for Connection "1", "2", "3" and "4"

Possible values of the attribute ANSCHLUSSART (CONNECTION\_TYPE):

1000x	Butt-welded	<p><b>Provide auxiliary part when fitting part</b> If appropriately preset in the ANSCHLUSSART (CONNECTION_TYPE) attribute for a connection, the part will provide and connect an auxiliary part of the standard specified in the attribute for the connection when being fitted. For example, if the part has a flange connection and the corresponding counter-flange is required, the content of the ANSCHLUSSART (CONNECTION_TYPE) attribute could look as follows: <b>20002 1 5100010 EN 1092-1/11/A/PN 40</b> <b>EN 1092-1/11/A/PN 40</b> is the standard designation with which the flange is to be entered into the database.</p>
2000x	Flange connection	
2100x	Flange with groove connection	
2200x	Flange with notch connection	
2040x	Flange connection of a part that is not a flange itself. The part has a loose flange that is modelled as a sub-part and has no own article master attached to this connection.	
3100x	Screwed, nipple	
3200x	Screwed, socket	
4100x	Plugged, nipple	
4200x	Plugged, socket	
5100x	Socket-welded, nipple	
5200x	Socket-welded, socket	

The last character (x) provides information about the meaning of the supplement:

**0**=No supplement

**2**= The supplement consists of connection number, part type, ID, and standard of the part to be connected

The prefixed connection number indicates the connection with which the auxiliary part is to be attached to the current connection.



Please also read the information given in the paragraphs Connection type ID with priority information and Connection type ID - List of part standards.



### Handling of nominal diameters in inches in the HELIOS database:

During part data synchronization, nominal diameters in inches will be taken over to the attributes N\_INCH, N2\_INCH and N3\_. The usual character strings for indication of the diameter in inches (e.g. 1 1/2" instead of 1.5) will be auto-generated in the database for the attributes NPS\_INCH, NPS2\_INCH und NPS3\_INCH.



## Variant for Part Type: Gauge part



Position of connecting points and determination of insertion lengths for various connection types			
Connection for butt welding	Flange connection	Connecting nipple for screwed, plugged or socket-welded connection	Connecting socket for screwed, plugged or socket-welded connection
a = Insertion length dimension (e.g. L, L1 etc.)	a = Insertion length dimension (e.g. L, L1 etc.)	a = Insertion length dimension (e.g. L, L1 etc.)	a = Insertion length dimension (e.g. L, L1 etc.)

### Named isolated points

Designation	Purpose	Comment	Position in coordinate system
!	Connecting point	Fitting point	in origin (0,0,0)
2	Auxiliary point or Connecting point		$X > 0, Y = 0, Z > 0$

### Variables names

Name	Description	Attribute (optional)
L	Distance between point "!" and "2"	LAENGE

If the variables names given in the **Name** column are used, you do not need to assign any attributes to them via the Variant Editor. If different variables are required, you need to assign the attributes given in the **Attribute** column..

### VAA file

Use the Variant Editor to enter the suitable part type into the VAA file.

Then, use the Variant Editor to expand the VAA file in such a way that it contains values for the sizes specified here, and that the predefined attribute assignment is entered.:

Parameter	Variable (suggestion)	Assigned attribute
All dimensions must be specified in millimetres; Exception: Nominal diameters in inches		
Nominal diameter, Connection "1" and "2"	N	NENNWEITE
<b>Additionally (only if the corresponding standard uses nominal diameters in inches):</b>		
Nominal diameter (inches), Connection "1"	NI	N_INCH
Nominal diameters in inches need to be entered as decimal values as well (e.g. 1.5 for 1 1/2").		
<b>These parameters are to be considered for all connection types except for flange connections. For connecting sockets they refer to the pipe to be inserted:</b>		
Outer diameter , Connection "1" and "2"	D	D_AUSSEN
Wall thickness, Connection "1" and "2"	S	WANDDICKE

If required, the attribute LAENGE needs to be assigned to the length variables. (see Variables names above).

For variant synchronization you also need to enter the values for the attributes which are to apply to all sub-types of the variant.

Values must be entered for at least the following attributes:

Attribute	Description
BENENNUNG	Designation of part
COMPONENT_TYPE	Part type (always = Semi-finished material + Plant Engineering) <u>for HELIOS database only</u>
NORMBEZEICHNUNG	Standard designation of the part (identical for all sub-types!) An entry is mandatory, even if the part corresponds to no standard.
ANSCHLUSSART	Connection type for Connection "1"
ANSCHLUSSART2	Connection type for Connection "2" (= "0", if only one connection exists)

Possible values of the attribute ANSCHLUSSART (CONNECTION\_TYPE):

- 1000x Butt-welded
- 2000x Flange connection
- 2100x Flange with groove connection
- 2200x Flange with notch connection
- 2040x Flange connection of a part that is not a flange itself. The part has a loose flange that is modelled as a sub-part and has no own article master attached to this connection.
- 3100x Screwed, nipple
- 3200x Screwed, socket
- 4100x Plugged, nipple
- 4200x Plugged, socket
- 5100x Socket-welded, nipple
- 5200x Socket-welded, socket

**Provide auxiliary part when fitting part**

If appropriately preset in the ANSCHLUSSART (CONNECTION\_TYPE) attribute for a connection, the part will provide and connect an auxiliary part of the standard specified in the attribute for the connection when being fitted. For example, if the part has a flange connection and the corresponding counter-flange is required, the content of the ANSCHLUSSART (CONNECTION\_TYPE) attribute could look as follows:  
**20002 1 5100010 EN 1092-1/11/A/PN 40**  
**EN 1092-1/11/A/PN 40** is the standard designation with which the flange is to be entered into the database.

The last character (x) provides information about the meaning of the supplement:

**0**=No supplement

**2**= The supplement consists of connection number, part type, ID, and standard of the part to be connected

The prefixed connection number indicates the connection with which the auxiliary part is to be attached to the current connection.



Please also read the information given in the paragraphs Connection type ID with priority information and Connection type ID - List of part standards.



**Handling of nominal diameters in inches in the HELIOS database:**

During part data synchronization, nominal diameters in inches will be taken over to the attributes N\_INCH, N2\_INCH and N3\_. The usual character strings for indication of the diameter in inches (e.g. 1 1/2" instead of 1.5) will be auto-generated in the database for the attributes NPS\_INCH, NPS2\_INCH und NPS3\_INCH.

### Variant for Part Type: Reducer, Excentric

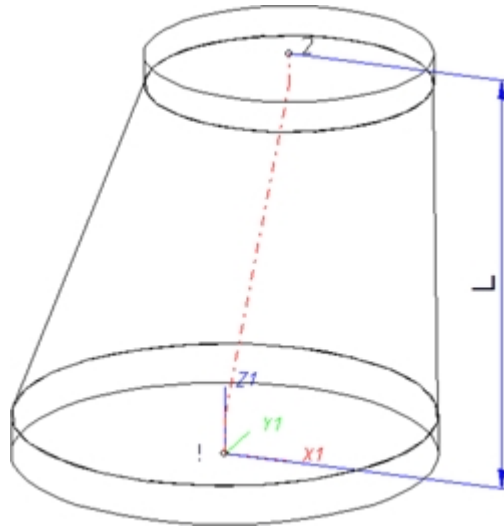

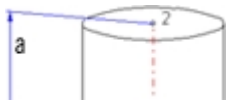
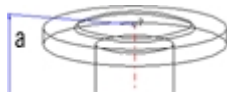
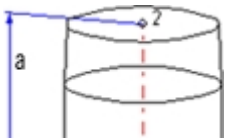
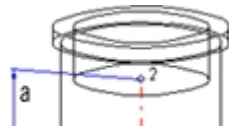
Position of connecting points and determination of insertion lengths for various connection types			
Connection for butt welding	Flange connection	Connecting nipple for screwed, plugged or socket-welded connection	Connecting socket for screwed, plugged or socket-welded connection
			
a = Insertion length dimension (e.g. L, L1 etc.)	a = Insertion length dimension (e.g. L, L1 etc.)	a = Insertion length dimension (e.g. L, L1 etc.)	a = Insertion length dimension (e.g. L, L1 etc.)

#### Named isolated points

Designation	Purpose	Comment	Position in coordinate system
!	Connecting point	Fitting point	in origin (0,0,0)
2	Connecting point		$X > 0, Y = 0, Z > 0$

#### Variables names

Name	Description	Attribute (optional)
L	Distance of the connecting surfaces from “!” to “2”	LAENGE

If the variables names given in the **Name** column are used, you do not need to assign any attributes to them via the Variant Editor. If different variables are required, you need to assign the attributes given in the **Attribute** column..

**VAA file:**

Use the Variant Editor to enter the suitable part type into the VAA file.

Then, use the Variant Editor to expand the VAA file in such a way that it contains values for the sizes specified here, and that the predefined attribute assignment is entered:

Parameter All dimensions must be specified in mil- limetres; Exception: Nominal diameters in inches	Variable (suggestion)	Assigned attribute
Nominal diameter, Connection “!“	N	NENNWEITE
Nominal diameter, Connection “2“	N2	NENNWEITE2
<b>Additionally (only if the corresponding standard uses nominal diameters in inches):</b>		
Nominal diameter (inches), Con- nection “!“	NI	N_INCH
Nominal diameter (inches), Con- nection “2“	NI2	N2_INCH
Nominal diameters in inches need to be entered as decimal values as well (e.g. 1.5 for 1 1/2“).		
<b>These parameters are to be considered for all connection types except for flange connections. For con- necting sockets they refer to the pipe to be inserted:</b>		
Outer diameter, Connection “!“	D	D_AUSSEN
Outer diameter, Connection “2“	D2	D2_AUSSEN
Wall thickness, Connection “!“	S	WANDDICKE
Wall thickness, Connection “2“	S2	WANDDICKE2

If required, the attributes LAENGE needs to be assigned to the length variables. (see Variables names above)

For variant synchronization you also need to enter the values for the attributes which are to apply to all sub-types of the variant.

Values must be entered for at least the following attributes:

Attribute	Description
BENENNUNG	Designation of the part
COMPONENT_TYPE	Part type (always = Semi-finished material + Plant Engineering) <u>for HELIOS database only</u>
NORMBEZEICHNUNG	Standard designation of the part (identical for all sub-types!) An entry is mandatory, even if the part corresponds to no stand- ard.
ANSCHLUSSART	Connection type for connection “!“
ANSCHLUSSART2	Connection type for connection “2“
Possible values of the attribute ANSCHLUSSART (CONNECTION_TYPE):	

Attribute	Description
1000x	Butt-welded
2000x	Flange connection
2100x	Flange with groove connection
2200x	Flange with notch connection
2040x	Flange connection of a part that is not a flange itself. The part has a loose flange that is modelled as a sub-part and has no own article master attached to this connection.
3100x	Screwed, nipple
3200x	Screwed, socket
4100x	Plugged, nipple
4200x	Plugged, socket
5100x	Socket-welded, nipple
5200x	Socket-welded, socket
<p>The last character (x) provides information about the meaning of the supplement:</p>	
<p><b>0</b>=No supplement</p>	
<p><b>2</b>= The supplement consists of connection number, part type, ID, and standard of the part to be connected</p>	
<p>The prefixed connection number indicates the connection with which the auxiliary part is to be attached to the current connection.</p>	
<p> Please also read the information given in the paragraphs Connection type ID with priority information and Connection type ID - List of part standards.</p>	

 **Handling of nominal diameters in inches in the HELiOs database:**

During part data synchronization, nominal diameters in inches will be taken over to the attributes N\_INCH, N2\_INCH and N3\_. The usual character strings for indication of the diameter in inches (e.g. 1 1/2" instead of 1.5) will be auto-generated in the database for the attributes NPS\_INCH, NPS2\_INCH und NPS3\_INCH.

### Variant for Part Type: Reducer, Concentric

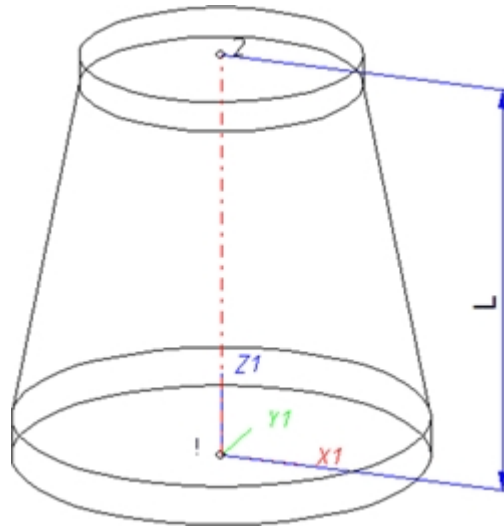

Position of connecting points and determination of insertion lengths for various connection types			
Connection for butt welding	Flange connection	Connecting nipple for screwed, plugged or socket-welded connection	Connecting socket for screwed, plugged or socket-welded connection
a = Insertion length dimension (e.g. L, L1 etc.)	a = Insertion length dimension (e.g. L, L1 etc.)	a = Insertion length dimension (e.g. L, L1 etc.)	a = Insertion length dimension (e.g. L, L1 etc.)

#### Named isolated points

Designation	Purpose	Comment	Position in coordinate system
!	Connecting point	Fitting point	in origin (0,0,0)
2	Connecting point		X > 0, Y = 0, Z > 0

#### Variables names

Name	Description	Attribute (optional)
L	Distance between point "!" and "2"	LAENGE

If the variables names given in the **Name** column are used, you do not need to assign any attributes to them via the Variant Editor. If different variables are required, you need to assign the attributes given in the **Attribute** column.

#### VAA file:

Use the Variant Editor to enter the suitable part type into the VAA file.



Then, use the Variant Editor to expand the VAA file in such a way that it contains values for the sizes specified here, and that the predefined attribute assignment is entered:

Parameter All dimensions must be specified in mil- limetres; Exception: Nominal diameters in inches	Variable (suggestion)	Assigned attribute
Nominal diameter, Connection “1”	N	NENNWEITE
Nominal diameter, Connection “2”	N2	NENNWEITE2
<b>Additionally (only if the corresponding standard uses nominal diameters in inches):</b>		
Nominal diameter (inches), Con- nection “1”	NI	N_INCH
Nominal diameter (inches), Con- nection “2”	NI2	N2_INCH
Nominal diameters in inches need to be entered as decimal values as well (e.g. 1.5 for 1 1/2”).		
<b>These parameters are to be considered for all connection types except for flange connections. For con- necting sockets they refer to the pipe to be inserted:</b>		
Outer diameter, Connection “1”	D	D_AUSSEN
Outer diameter, Connection “2”	D2	D2_AUSSEN
Wall thickness, Connection “1”	S	WANDDICKE
Wall thickness, Connection “2”	S2	WANDDICKE2

If required, the attributes LAENGE needs to be assigned to the length variables. (see Variables names above).

For variant synchronization you also need to enter the values for the attributes which are to apply to all sub-types of the variant.

Values must be entered for at least the following attributes:

Attribute	Description
BENENNUNG	Designation of the part
COMPONENT_TYPE	Part type (always = Semi-finished material + Plant Engineering) <u>for HELIOS database only</u>
NORMBEZEICHNUNG	Standard designation of the part (identical for all sub-types!) An entry is mandatory, even if the part corresponds to no stand- ard.
ANSCHLUSSART	Connection type for connection “1”
ANSCHLUSSART2	Connection type for connection “2”
Possible values of the attribute ANSCHLUSSART (CONNECTION_TYPE):	



Attribute		Description
1000x	Butt-welded	<p><b>Provide auxiliary part when fitting part</b></p> <p>If appropriately preset in the ANSCHLUSSART (CONNECTION_TYPE) attribute for a connection, the part will provide and connect an auxiliary part of the standard specified in the attribute for the connection when being fitted. For example, if the part has a flange connection and the corresponding counter-flange is required, the content of the ANSCHLUSSART (CONNECTION_TYPE) attribute could look as follows:  <b>20002 1 5100010 EN 1092-1/11/A/PN 40</b>  <b>EN 1092-1/11/A/PN 40</b> is the standard designation with which the flange is to be entered into the database.</p>
2000x	Flange connection	
2100x	Flange with groove connection	
2200x	Flange with notch connection	
2040x	Flange connection of a part that is not a flange itself. The part has a loose flange that is modelled as a sub-part and has no own article master attached to this connection.	
3100x	Screwed, nipple	
3200x	Screwed, socket	
4100x	Plugged, nipple	
4200x	Plugged, socket	
5100x	Socket-welded, nipple	
5200x	Socket-welded, socket	
<p>The last character (x) provides information about the meaning of the supplement:  <b>0</b>=No supplement  <b>2</b>= The supplement consists of connection number, part type, ID, and standard of the part to be connected                      The prefixed connection number indicates the connection with which the auxiliary part is to be attached to the current connection.</p>		
 <p>Please also read the information given in the paragraphs Connection type ID with priority information and Connection type ID - List of part standards.</p>		

 **Handling of nominal diameters in inches in the HELiOS database:**

During part data synchronization, nominal diameters in inches will be taken over to the attributes N\_INCH, N2\_INCH and N3\_. The usual character strings for indication of the diameter in inches (e.g. 1 1/2" instead of 1.5) will be auto-generated in the database for the attributes NPS\_INCH, NPS2\_INCH und NPS3\_INCH.

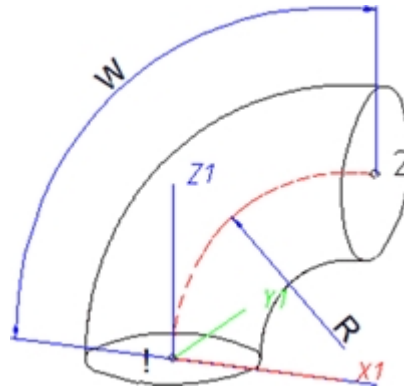
### Variant for Part Type: Elbow

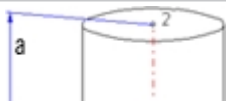
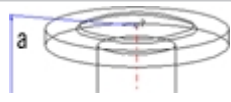

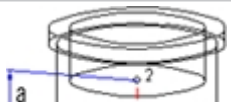
Position of connecting points and determination of insertion lengths for various connection types			
Connection for butt welding	Flange connection	Connecting nipple for screwed, plugged or socket-welded connection	Connecting socket for screwed, plugged or socket-welded connection
			
a = Insertion length dimension (e.g. L, L1 etc.)	a = Insertion length dimension (e.g. L, L1 etc.)	a = Insertion length dimension (e.g. L, L1 etc.)	a = Insertion length dimension (e.g. L, L1 etc.)

### Named isolated points

Designation	Purpose	Comment	Position in coordinate system
!	Connecting point	Fitting point	in origin (0,0,0)
2	Connecting point		$X > 0, Y = 0, Z > 0$

**VAA file**

Use the Variant Editor to enter the suitable part type into the VAA file.

Then, use the Variant Editor to expand the VAA file in such a way that it contains values for the sizes specified here, and that the predefined attribute assignment is entered:

Parameter All dimensions must be specified in mil- limetres; Exception: Nominal diameters in inches	Variable (suggestion)	Assigned attribute
Nominal diameter, Connection “!” and “2”	N	NENNWEITE
Angle	W	WINKEL
Bend radius	R	KRUEMMUNG
<b>Additionally (only if the corresponding standard uses nominal diameters in inches):</b>		
Nominal diameter (inches), Con- nection “!” and “2”	NI	N_INCH
Nominal diameters in inches need to be entered as decimal values as well (e.g. 1.5 for 1 1/2”).		
<b>These parameters are to be considered for all connection types except for flange connections. For con- necting sockets they refer to the pipe to be inserted:</b>		
Outer diameter, Connection “!” and “2”	D	D_AUSSEN
Wall thickness, Connection “!” and “2”	S	WANDDICKE

For variant synchronization you also need to enter the values for the attributes which are to apply to all sub-types of the variant.

Values must be entered for at least the following attributes:

Attribute	Description
BENENNUNG	Designation of the part
COMPONENT_TYPE	Part type (always = Semi-finished material + Plant Engineering) <u>for HELIOS database only</u>
NORMBEZEICHNUNG	Standard designation of the part (identical for all sub-types!) An entry is mandatory, even if the part corresponds to no stand- ard.
BELIEBIG_TEILBAR	Indicates whether a cutting to length of the elbow is permissible.
ANSCHLUSSART	Connection type for connections “!” and “2” The connection types on both ends must be identical.
Possible values of the attribute ANSCHLUSSART (CONNECTION_TYPE):	

Attribute	Description
1000x	Butt-welded
2000x	Flange connection
2100x	Flange with groove connection
2200x	Flange with notch connection
2040x	Flange connection of a part that is not a flange itself. The part has a loose flange that is modelled as a sub-part and has no own article master attached to this connection.
3100x	Screwed, nipple
3200x	Screwed, socket
4100x	Plugged, nipple
4200x	Plugged, socket
5100x	Socket-welded, nipple
5200x	Socket-welded, socket
<p>The last character (x) provides information about the meaning of the supplement:</p>	
<p><b>0</b>=No supplement</p>	
<p><b>2</b>= The supplement consists of connection number, part type, ID, and standard of the part to be connected</p>	
<p>The prefixed connection number indicates the connection with which the auxiliary part is to be attached to the current connection.</p>	
<p> Please also read the information given in the paragraphs Connection type ID with priority information and Connection type ID - List of part standards.</p>	

 **Handling of nominal diameters in inches in the HELiOs database:**

During part data synchronization, nominal diameters in inches will be taken over to the attributes N\_INCH, N2\_INCH and N3\_. The usual character strings for indication of the diameter in inches (e.g. 1 1/2" instead of 1.5) will be auto-generated in the database for the attributes NPS\_INCH, NPS2\_INCH und NPS3\_INCH.

## Variant for Part Type: Pipe Clamp

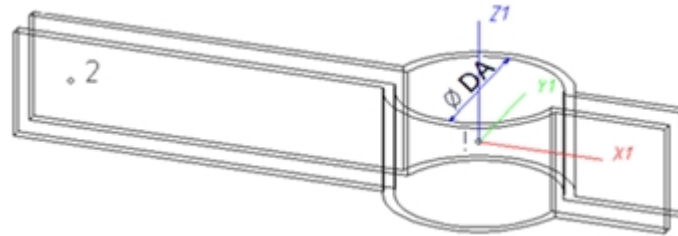

### Named isolated points

Designation	Purpose	Comment	Position in coordinate system
!	Fitting point	Reference point placed on the centre line of a pipe during fitting	in origin (0,0,0)
2	Auxiliary point		$X < 0, Y = 0, Z = 0$

### VAA file

Use the Variant Editor to enter the suitable part type into the VAA file.

Then, use the Variant Editor to expand the VAA file in such a way that it contains values for the sizes shown below, and that the predefined attribute assignment is entered.

#### Possibility 1:

Parameter	Variable (suggestion)	Assigned attribute
All dimensions must be specified in millimetres; Exception: Nominal diameters in inches		
<b>These parameters apply to pipes which fit into the clamps</b>		
Nominal diameter	N	NENNWEITE
Outer diameter	DA	D_AUSSEN
<b>Additionally (only if the corresponding standard uses nominal diameters in inches):</b>		
Nominal diameter (inches)	NI	N_INCH
Nominal diameters in inches need to be entered as decimal values as well (e.g. 1.5 for 1 1/2").		

#### Possibility 2:

Parameter	Variable (suggestion)	Assigned attribute
All dimensions must be specified in millimetres; Exception: Nominal diameters in inches		
<b>These parameters apply to pipes which fit into the clamps</b>		
Outer diameter Largest possible outer diameter of pipe that is still suitable for pipe clamp	DA	D_AUSSEN

Parameter	Variable (suggestion)	Assigned attribute
All dimensions must be specified in millimetres; Exception: Nominal diameters in inches		
Outer diameter 2 Smallest possible outer diameter of pipe that is still suitable for pipe clamp	D2	D2_AUSSEN
Nominal diameter	N	NENNWEITE
<b>Additionally (only if the corresponding standard uses nominal diameters in inches):</b>		
Nominal diameter (inches)	NI	N_INCH
Nominal diameters in inches need to be entered as decimal values as well (e.g. 1.5 for 1 1/2").		

For variant synchronization you also need to enter the values for the attributes which are to apply to all sub-types of the variant.

Values must be entered for at least the following attributes:

Attribute	Description
BENENNUNG (DESIGNATION)	Designation of the part
COMPONENT_TYPE	Part type (always = Semi-finished material + Plant Engineering) <u>for HELiOS database only</u>
NORMBEZEICHNUNG (STANDARD_DESIGNATION)	Standard designation of the part (identical for all sub-types!) An entry is mandatory, even if the part corresponds to no standard.



#### Handling of nominal diameters in inches in the HELiOS database:

During part data synchronization, nominal diameters in inches will be taken over to the attributes N\_INCH, N2\_INCH and N3\_. The usual character strings for indication of the diameter in inches (e.g. 1 1/2" instead of 1.5) will be auto-generated in the database for the attributes NPS\_INCH, NPS2\_INCH und NPS3\_INCH.



For the insertion of a pipe clamp having these two outer diameter attributes the **Also use Outer diameter 2 as search criterion for pipe clamps** checkbox on the **Part search** tab of the **Plant Engineering Settings** dialogue must be active.

## Variant for Part Type: Vessels, Pumps, Other Components

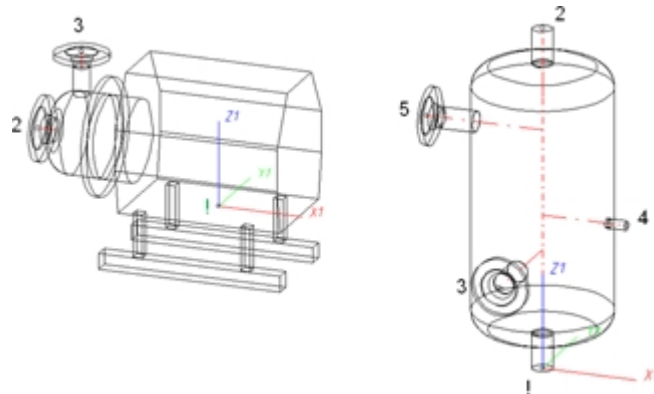

### Named isolated points

Designation	Purpose	Description	Position in coordinate system
!	Connecting point or auxiliary point	Fitting point	in origin (0,0,0)
2, 3, 4 etc., unambiguous within the part	Connecting points or auxiliary points		arbitrary

Connecting points should preferably be created via the Component connection function, or (for various components) by the insertion of nozzles.

Each component connection (and the fitting point, if it is an auxiliary point) needs to be located in a plane belonging to the part. It needs however not be located within the surface boundary.

#### Example:

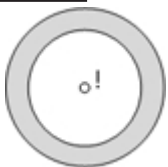

If the connecting point is located in the plane of the ring surface, the surface condition is fulfilled.

Caution: It would also be fulfilled if the point would be located in the same plane, but outside of the ring.

To assign an unambiguous orientation to a connection, a connecting point must not fulfil the surface condition for several surfaces at once.

### VAA file

Use the Variant Editor to enter the suitable part type into the VAA file.

Then, use the Variant Editor to expand the VAA file in such a way that appropriate attributes such as HOEHE (HEIGHT), BREITE (WIDTH), LAENGE (LENGTH) etc. are assigned to the individual variables, enabling a distinguishing between various sub-types during part selection.

For variant synchronization you also need to enter the values for the attributes which are to apply to all sub-types of the variant.



Values must be entered for at least the following attributes:

AttributE	Description
BENENNUNG	Designation of the part
COMPONENT_TYPE	Part type (always = Semi-finished material+Plant Engineering) <u>for HELIOS database only</u>
NORMBEZEICHNUNG	Standard designation of the part (identical for all sub-types!) An entry is mandatory, even if the part corresponds to no standard.

## Variant for Part Type: Nozzle

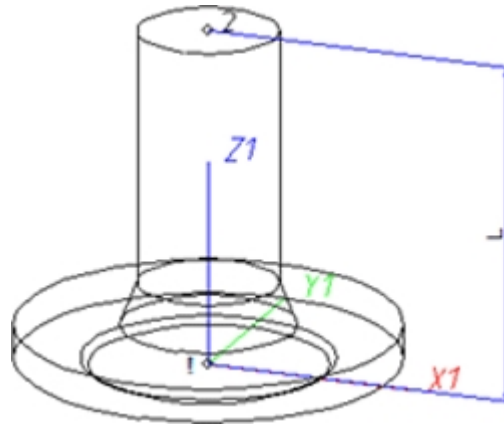

Position of connecting points and determination of insertion lengths for various connection types			
Connection for butt welding	Flange connection	Connecting nipple for screwed, plugged or socket-welded connection	Connecting socket for screwed, plugged or socket-welded connection
a = Insertion length dimension (e.g. L, L1 etc.)	a = Insertion length dimension (e.g. L, L1 etc.)	a = Insertion length dimension (e.g. L, L1 etc.)	a = Insertion length dimension (e.g. L, L1 etc.)

### Named isolated points

Designation	Purpose	Comment	Position in coordinate system
!	Connecting point	Fitting point	in origin (0,0,0)
2	Connecting point		X = 0, Y = 0, Z > 0

### Variables names

Name	Description	Attribute (optional)
L	Length of distance between points "!" and "2"	LAENGE

If the variables names given in the **Name** column are used, you do not need to assign any attributes to them via the Variant Editor. If different variables are required, you need to assign the attributes given in the **Attribute** column.

### VAA file

Use the Variant Editor to enter the suitable part type into the VAA file.

Then, use the Variant Editor to expand the VAA file in such a way that it contains values for the sizes specified here, and that the predefined attribute assignment is entered:

Parameter All dimensions must be specified in millimetres; Exception: Nominal diameters in inches	Variable (suggestion)	Assigned attribute
Nominal diameter, Connection “1” and “2”	N	NENNWEITE
Nominal diameter, Connection “3” and “4”	N3	NENNWEITE3
<b>Additionally (only if the corresponding standard uses nominal diameters in inches):</b>		
Nominal diameter (inches), Connection “1” and “2”	NI	N_INCH
Nominal diameter (inches), Connection “3” and “4”	NI3	N3_INCH
Nominal diameters in inches need to be entered as decimal values as well (e.g. 1.5 for 1 1/2”).		
<b>These parameters are to be considered for all connection types except for flange connections. For connecting sockets they refer to the pipe to be inserted:</b>		
Outer diameter, Connection “1” and “2”	D	D_AUSSEN
Outer diameter, Connection “3” and “4”	D3	D3_AUSSEN
Wall thickness, Connection “1” and “2”	S	WANDDICKE
Wall thickness, Connection “3” and “4”	S3	WANDDICKE3

If required, the attribute LAENGE need to be assigned to the length variables. (see Variables names above).

For variant synchronization you also need to enter the values for the attributes which are to apply to all sub-types of the variant.

Values must be entered for at least the following attributes:

Attribute	Description
BENENNUNG	Designation of part
COMPONENT_TYPE	Part type (always = Semi-finished material + Plant Engineering) <u>for HELiOS database only</u>
NORMBEZEICHNUNG	Standard designation of the part (identical for all sub-types!) An entry is mandatory, even if the part corresponds to no standard.
ANSCHLUSSART	Connection type for connection "1"
ANSCHLUSSART2	Connection type for connection "2" (value always 10000)

Possible values of the attribute ANSCHLUSSART (CONNECTION\_TYPE):.

1000x	Butt-welded
2000x	Flange connection
2100x	Flange with groove connection
2200x	Flange with notch connection
2040x	Flange connection of a part that is not a flange itself. The part has a loose flange that is modelled as a sub-part and has no own article master attached to this connection.
3100x	Screwed, nipple
3200x	Screwed, socket
4100x	Plugged, nipple
4200x	Plugged, socket
5100x	Socket-welded, nipple
5200x	Socket-welded, socket

**Provide auxiliary part when fitting part**

If appropriately preset in the ANSCHLUSSART (CONNECTION\_TYPE) attribute for a connection, the part will provide and connect an auxiliary part of the standard specified in the attribute for the connection when being fitted. For example, if the part has a flange connection and the corresponding counter-flange is required, the content of the ANSCHLUSSART (CONNECTION\_TYPE) attribute could look as follows:  
**20002 1 5100010 EN 1092-1/11/A/PN 40**  
**EN 1092-1/11/A/PN 40** is the standard designation with which the flange is to be entered into the database.

The last character (x) provides information about the meaning of the supplement:

**0**=No supplement

**2**= The supplement consists of connection number, part type, ID, and standard of the part to be connected

The prefixed connection number indicates the connection with which the auxiliary part is to be attached to the current connection.



Please also read the information given in the paragraphs Connection type ID with priority information and Connection type ID - List of part standards.



**Handling of nominal diameters in inches in the HELiOS database:**

During part data synchronization, nominal diameters in inches will be taken over to the attributes N\_INCH, N2\_INCH and N3\_. The usual character strings for indication of the diameter in inches (e.g. 1 1/2" instead of 1.5) will be auto-generated in the database for the attributes NPS\_INCH, NPS2\_INCH und NPS3\_INCH.

## Variant for Part Type: Other Pipe Parts

Up to 4 connections are possible for this part type.

The connections "1" and "2" need to be located on the Z-axis. The position of further connections is arbitrary. However, connections "3" and "4" cannot process guidelines during part insertion. The creation of guidelines starting from connections "3" and "4" can only be performed subsequently. Therefore, you will only have the following fitting options:

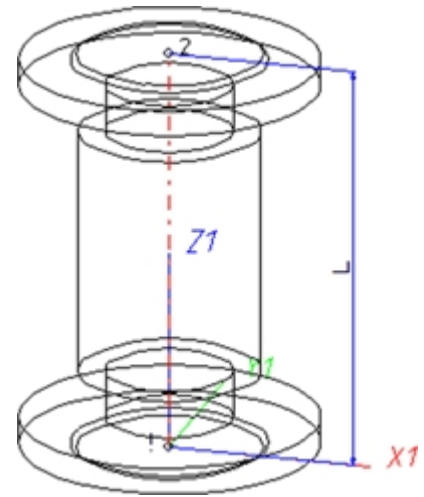
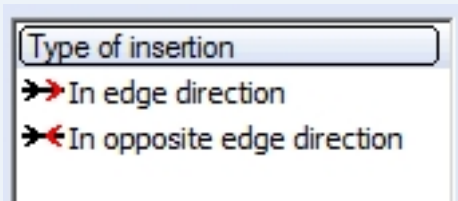

Example: Compensator with flanges

### Position of connecting points and determination of insertion lengths for various connection types

Connection for butt welding	Flange connection	Connecting nipple for screwed, plugged or socket-welded connection	Connecting socket for screwed, plugged or socket-welded connection
a = Insertion length dimension (e.g. L, L1 etc.)	a = Insertion length dimension (e.g. L, L1 etc.)	a = Insertion length dimension (e.g. L, L1 etc.)	a = Insertion length dimension (e.g. L, L1 etc.)

### Named isolated points

Designation	Purpose	Comment	Position in coordinate system
!	Connecting point	Fitting point	in origin (0,0,0)
2	Connecting point		X = 0, Y = 0, Z > 0
3	Connecting point	optional	arbitrary
4	Fiting point	optional	arbitrary

### Variables names

Name	Description	Attribut (optional)
L	Distance between point "!" and "2"	LAENGE

If the variables names given in the **Name** column are used, you do not need to assign any attributes to them via the Variant Editor. If different variables are required, you need to assign the attributes given in the **Attribute** column.

### VAA file

Use the Variant Editor to enter the suitable part type into the VAA file.

Then, use the Variant Editor to expand the VAA file in such a way that it contains values for the sizes specified here, and that the predefined attribute assignment is entered.

Parameter All dimensions must be specified in millimetres; Exception: Nominal diameters in inches	Variable (suggestion)	Assigned attribute
Nominal diameter, Connection “!” and “2”	N	NENNWEITE
<b>Additionally (only if the corresponding standard uses nominal diameters in inches):</b>		
Nominal diameter (inches), Connection “!” and “2”	NI	N_INCH
Nominal diameters in inches need to be entered as decimal values as well (e.g. 1.5 for 1 1/2”).		
<b>These parameters are to be considered for all connection types except for flange connections. For connecting sockets they refer to the pipe to be inserted:</b>		
Outer diameter, Connection “!” and “2”	D	D_AUSSEN
Wall thickness, Connection “!” and “2”	S	WANDDICKE

If required, the attributes LAENGE needs to be assigned to the length variables. (see Variables names above).

As mentioned above, the part may have up to 4 connections. If a connection "4" exists, it needs to have the same properties (Nominal diameter, Outer diameter, Wall thickness, Connection type) as connection "3". For three connections, various properties can be preset:

Parameter	Variable (suggestion)	Assigned attribute
Nominal diameter, Connection "1"	N	NENNWEITE
Nominal diameter, Connection "2"	N2	NENNWEITE2
Nominal diameter, Connection "3" [and "4"]	N3	NENNWEITE3
Nominal diameter (inches) , Connection "1"	NI	N_INCH
Nominal diameter (inches), Connection "2"	NI2	N2_INCH
Nominal diameter (inches) , Connection "3" [and "4"]	NI3	N3_INCH
Outer diameter, Connection "1"	D	D_AUSSEN
Outer diameter, Connection "2"	D2	D2_AUSSEN
Outer diameter, Connection "3" [and "4"]	D3	D3_AUSSEN
Wall thickness, Connection "1"	S	WANDDICKE
Wall thickness, Connection "2"	S2	WANDDICKE2
Wall thickness, Connection "3" [and "4"]	S3	WANDDICKE3

For variant synchronization you also need to enter the values for the attributes which are to apply to all sub-types of the variant.

Values must be entered for at least the following attributes:

Attribute	Description
BENENNUNG	Part type designation
COMPONENT_TYPE	Part type (always = Semi-finished material + Plant Engineering) <u>for HELiOS database only</u>
NORMBEZEICHNUNG	Standard designation of the part (identical for all sub-types!) An entry is mandatory, even if the part corresponds to no standard.
ANSCHLUSSART	Connection type for all connections
<i>ANSCHLUSSART2</i>	<i>Connection type for connection "2", if different from that for connection "1"</i>
<i>ANSCHLUSSART3</i>	<i>Connection type for connection "3" [and "4"], if different from that for connection "2" n</i>

Possible values of the attribute ANSCHLUSSART (CONNECTION\_TYPE):

- 1000x Butt-welded
- 2000x Flange connection
- 2100x Flange with groove connection
- 2200x Flange with notch connection
- 2040x Flange connection of a part that is not a flange itself. The part has a loose flange that is modelled as a sub-part and has no own article master attached to this connection.
- 3100x Screwed, nipple
- 3200x Screwed, socket
- 4100x Plugged, nipple
- 4200x Plugged, socket
- 5100x Socket-welded, nipple
- 5200x Socket-welded, socket

**Provide auxiliary part when fitting part**

If appropriately preset in the ANSCHLUSSART (CONNECTION\_TYPE) attribute for a connection, the part will provide and connect an auxiliary part of the standard specified in the attribute for the connection when being fitted. For example, if the part has a flange connection and the corresponding counter-flange is required, the content of the ANSCHLUSSART (CONNECTION\_TYPE) attribute could look as follows:

**20002 1 5100010 EN 1092-1/11/A/PN 40**

**EN 1092-1/11/A/PN 40** is the standard designation with which the flange is to be entered into the database.

The last character (x) provides information about the meaning of the supplement:

**0** = No supplement

**2** = The supplement consists of connection number, part type, ID, and standard of the part to be connected

The prefixed connection number indicates the connection with which the auxiliary part is to be attached to the current connection.



Please also read the information given in the paragraphs Connection type ID with priority information and Connection type ID - List of part standards.



**Handling of nominal diameters in inches in the HELiOS database:**



During part data synchronization, nominal diameters in inches will be taken over to the attributes N\_INCH, N2\_INCH and N3\_. The usual character strings for indication of the diameter in inches (e.g. 1 1/2" instead of 1.5) will be auto-generated in the database for the attributes NPS\_INCH, NPS2\_INCH und NPS3\_INCH.

### Variant for Part Type: T-Piece

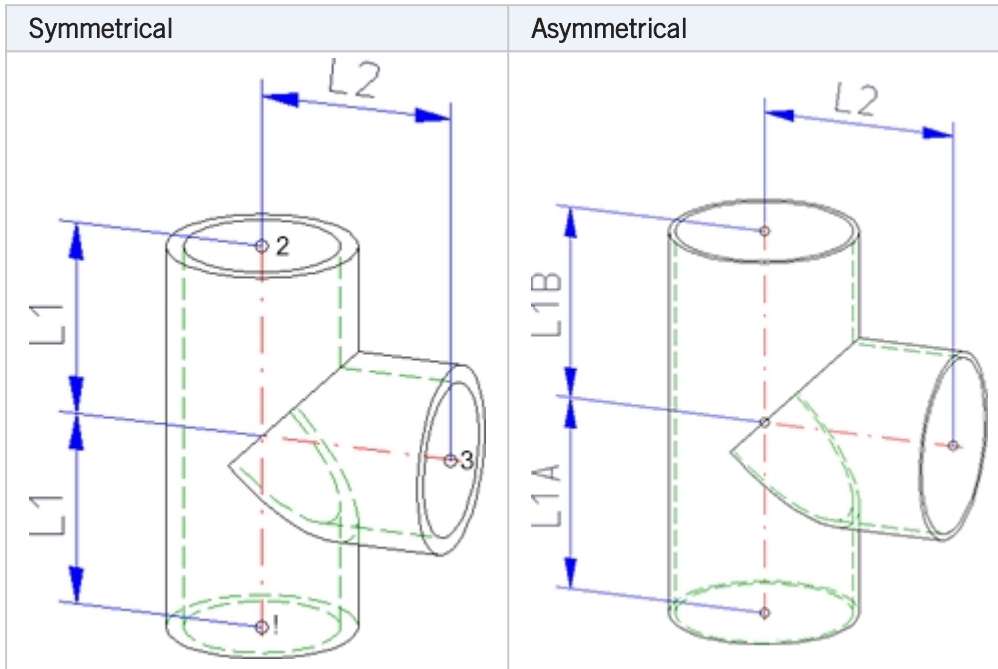

Position of connecting points and determination of insertion lengths for various connection types			
Connection for butt welding	Flange connection	Connecting nipple for screwed, plugged or socket-welded connection	Connecting socket for screwed, plugged or socket-welded connection
a = Insertion length dimension (e.g. L, L1 etc.)	a = Insertion length dimension (e.g. L, L1 etc.)	a = Insertion length dimension (e.g. L, L1 etc.)	a = Insertion length dimension (e.g. L, L1 etc.)

#### Named isolated points

Designation	Purpose	Comment	Position in coordinate system
!	Connecting point	Fitting point	in origin (0,0,0)
2	Connecting point		X = 0, Y = 0, Z > 0
3	Connecting point	on branch	X > 0, Y = 0, Z > 0

#### Variables names

Name	Description	Attribute (optional)
L1	Half the length of the distance between points "1" and "2"	LAENGE1
L2	Distance of point "3" from straight line through "1" and "2"	LAENGE3
L1A	Distance between the point "1" and the perpendicular from the point "3" onto the distance between the points "1" and "2"	
L1B	Distance between the point "2" and the perpendicular from the point "3" onto the distance between the points "1" and "2"	

**For asymmetrical T-pieces the following applies:**  
 If the variable L1 exists in the variant, the insertion length will be the double amount of L1. Otherwise, the insertion length will be the sum of L1A and L1B.

If the variables names given in the **Name** column are used, you do not need to assign any attributes to them via the Variant Editor. If different variables are required, you need to assign the attributes given in the **Attribute** column.

For asymmetrical T-pieces the additional variable L3 is available. If the variable L3 does not exist in the variant, the insertion length will be the double amount of L1. If L3 exists, the insertion length will be the sum of L1 and L2. This selection of designations corresponds to the length definitions of branchings.

**VAA file**

Use the Variant Editor to enter the suitable part type into the VAA file.

Then, use the Variant Editor to expand the VAA file in such a way that it contains values for the sizes specified here, and that the predefined attribute assignment is entered:

Parameter All dimensions must be specified in millimetres; Exception: Nominal diameters in inches	Variable (suggestion)	Assigned attribute
Nominal diameter, Connection "1" and "2"	N	NENNWEITE
Nominal diameter, Connection "3"	N3	NENNWEITE3
<b>Additionally (only if the corresponding standard uses nominal diameters in inches):</b>		
Nominal diameter (inches), Connection "1" and "2"	NI	N_INCH
Nominal diameter (inches), Connection "3"	NI3	N3_INCH
Nominal diameters in inches need to be entered as decimal values as well (e.g. 1.5 for 1 1/2").		
<b>These parameters are to be considered for all connection types except for flange connections. For connecting sockets they refer to the pipe to be inserted:</b>		
Outer diameter, Connection "1" and "2"	D	D_AUSSEN

Parameter All dimensions must be specified in millimetres; Exception: Nominal diameters in inches	Variable (suggestion)	Assigned attribute
Outer diameter, Connection "3"	D3	D3_AUSSEN
Wall thickness, Connection "1" and "2"	S	WANDDICKE
Wall thickness, Connection "3"	S3	WANDDICKE3

If required, the attributes LAENGE1 and LAENGE3 need to be assigned to the length variables. (see Variables names above).

For variant synchronization you also need to enter the values for the attributes which are to apply to all sub-types of the variant.

Values must be entered for at least the following attributes:

Attribute	Description
BENENNUNG	Designation of the part
COMPONENT_TYPE	Part type (always = Semi-finished material + Plant Engineering) <u>for HELIOS database only</u>
NORMBEZEICHNUNG	Standard designation of the part (identical for all sub-types!) An entry is mandatory, even if the part corresponds to no standard.
ANSCHLUSSART	Connection type for connections “1” and “2”
ANSCHLUSSART3	Connection type for connection “3”

Possible values of the attribute ANSCHLUSSART (CONNECTION\_TYPE):

- 1000x Butt-welded
- 2000x Flange connection
- 2100x Flange with groove connection
- 2200x Flange with notch connection
- 2040x Flange connection of a part that is not a flange itself. The part has a loose flange that is modelled as a sub-part and has no own article master attached to this connection.
- 3100x Screwed, nipple
- 3200x Screwed, socket
- 4100x Plugged, nipple
- 4200x Plugged, socket
- 5100x Socket-welded, nipple
- 5200x Socket-welded, socket

**Provide auxiliary part when fitting part**

If appropriately preset in the ANSCHLUSSART (CONNECTION\_TYPE) attribute for a connection, the part will provide and connect an auxiliary part of the standard specified in the attribute for the connection when being fitted. For example, if the part has a flange connection and the corresponding counter-flange is required, the content of the ANSCHLUSSART (CONNECTION\_TYPE) attribute could look as follows:

**20002 1 5100010 EN 1092-1/11/A/PN 40**

**EN 1092-1/11/A/PN 40** is the standard designation with which the flange is to be entered into the database.

The last character (x) provides information about the meaning of the supplement:

**0** = No supplement

**2** = The supplement consists of connection number, part type, ID, and standard of the part to be connected

The prefixed connection number indicates the connection with which the auxiliary part is to be attached to the current connection.



Please also read the information given in the paragraphs Connection type ID with priority information and Connection type ID - List of part standards.





**Handling of nominal diameters in inches in the HELIOS database:**

During part data synchronization, nominal diameters in inches will be taken over to the attributes N\_INCH, N2\_INCH and N3\_. The usual character strings for indication of the diameter in inches (e.g. 1 1/2“ instead of 1.5) will be auto-generated in the database for the attributes NPS\_INCH, NPS2\_INCH und NPS3\_INCH.

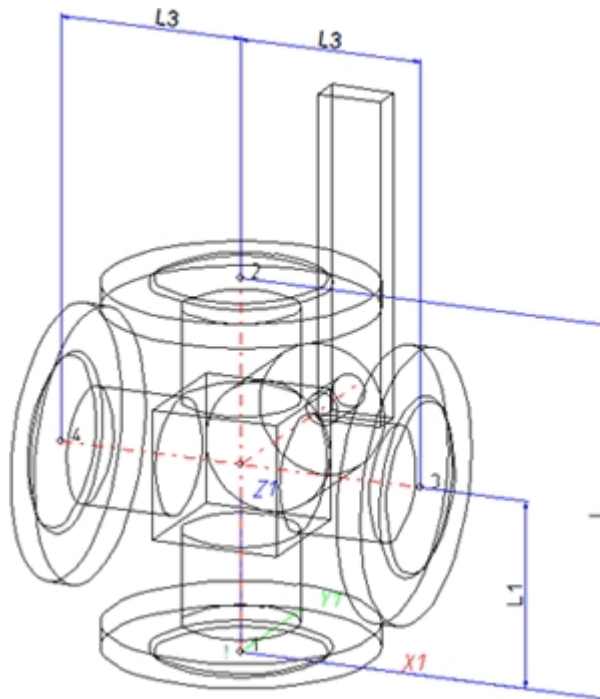
### Variant for Part Type: 4-Way Valve

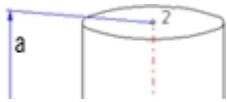
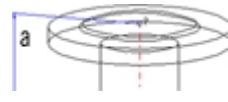

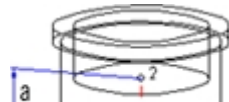
Position of connecting points and determination of insertion lengths for various connection types			
Connection for butt welding	Flange connection	Connecting nipple for screwed, plugged or socket-welded connection	Connecting socket for screwed, plugged or socket-welded connection
			
a = Insertion length dimension (e.g. L, L1 etc.)	a = Insertion length dimension (e.g. L, L1 etc.)	a = Insertion length dimension (e.g. L, L1 etc.)	a = Insertion length dimension (e.g. L, L1 etc.)

#### Named isolated points

Designation	Purpose	Comment	Position in coordinate system
!	Connecting point	Fitting point	in origin (0,0,0)
2	Connecting point		$X = 0, Y = 0, Z > 0$
3	Connecting point	on branch	$X > 0, Y = 0, Z > 0$
4	Connecting point	on branch	$X < 0, Y = 0, Z > 0$

**Variables names**

Name	Description	Attribute (optional)
L	Length of distance between points “1” and “2”	LAENGE
L1	Length of distance between points “1” and the intersection point of centre lines	LAENGE1
L3	Half the length of the distance between points “3” und “4”	LAENGE3

If the variables names given in the **Name** column are used, you do not need to assign any attributes to them via the Variant Editor. If different variables are required, you need to assign the attributes given in the **Attribute** column.

**VAA file**

Use the Variant Editor to enter the suitable part type into the VAA file.

Then, use the Variant Editor to expand the VAA file in such a way that it contains values for the sizes specified here, and that the predefined attribute assignment is entered:

Parameter	Variable (suggestion)	Assigned attribute
All dimensions must be specified in millimetres; Exception: Nominal diameters in inches		
Nominal diameter, Connection “1” and “2”	N	NENNWEITE
Nominal diameter, Connection “3” and “4”	N3	NENNWEITE3
<b>Additionally (only if the corresponding standard uses nominal diameters in inches):</b>		
Nominal diameter (inches), Connection “1” and “2”	NI	N_INCH
Nominal diameter (inches), Connection “3” and “4”	NI3	N3_INCH
Nominal diameters in inches need to be entered as decimal values as well (e.g. 1.5 for 1 1/2”).		
<b>These parameters are to be considered for all connection types except for flange connections. For connecting sockets they refer to the pipe to be inserted:</b>		
Outer diameter, Connection “1” and “2”	D	D_AUSSEN
Outer diameter, Connection “3” and “4”	D3	D3_AUSSEN
Wall thickness, Connection “1” and “2”	S	WANDDICKE
Wall thickness, Connection “3” and “4”	S3	WANDDICKE3

If required, the attributes LAENGE, LAENGE1 and LAENGE3 need to be assigned to the length variables (see Variables names above).

For variant synchronization you also need to enter the values for the attributes which are to apply to all sub-types of the variant.

Values must be entered for at least the following attributes:

Attribute	Description
BENENNUNG	Designation of part
COMPONENT_TYPE	Part type (always = Semi-finished material + Plant Engineering) <u>for HELIOS database only</u>
NORMBEZEICHNUNG	Standard designation of the part (identical for all sub-types!) An entry is mandatory, even if the part corresponds to no standard.
ANSCHLUSSART (CONNECTION_TYPE)	Connection type for Connection “1”, “2”, “3” and “4”
Possible values of the attribute ANSCHLUSSART (CONNECTION_TYPE):.	
1000x	Butt-welded
2000x	Flange connection
2100x	Flange with groove connection
2200x	Flange with notch connection
2040x	Flange connection of a part that is not a flange itself. The part has a loose flange that is modelled as a sub-part and has no own article master attached to this connection.
3100x	Screwed, nipple
3200x	Screwed, socket
4100x	Plugged, nipple
4200x	Plugged, socket
5100x	Socket-welded, nipple
5200x	Socket-welded, socket
<p>The last character (x) provides information about the meaning of the supplement:  <b>0</b>=No supplement  <b>2</b>= The supplement consists of connection number, part type, ID, and standard of the part to be connected                      The prefixed connection number indicates the connection with which the auxiliary part is to be attached to the current connection.</p> <p><b>Provide auxiliary part when fitting part</b>                      If appropriately preset in the ANSCHLUSSART (CONNECTION_TYPE) attribute for a connection, the part will provide and connect an auxiliary part of the standard specified in the attribute for the connection when being fitted. For example, if the part has a flange connection and the corresponding counter-flange is required, the content of the ANSCHLUSSART (CONNECTION_TYPE) attribute could look as follows:  <b>20002 1 5100010 EN 1092-1/11/A/PN 40</b>  <b>EN 1092-1/11/A/PN 40</b> is the standard designation with which the flange is to be entered into the database.</p>	
 Please also read the information given in the paragraphs Connection type ID with priority information and Connection type ID - List of part standards.	



**Handling of nominal diameters in inches in the HELIOS database:**

During part data synchronization, nominal diameters in inches will be taken over to the attributes N\_INCH, N2\_INCH and N3\_. The usual character strings for indication of the diameter in inches (e.g. 1 1/2“ instead of 1.5) will be auto-generated in the database for the attributes NPS\_INCH, NPS2\_INCH und NPS3\_INCH.



## Variant for Part Type: Seal

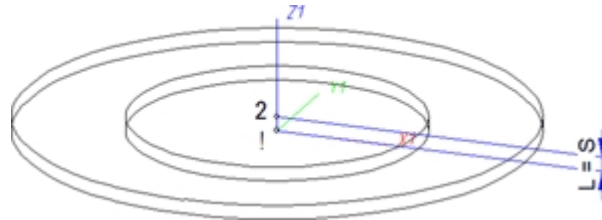

### Named isolated points

Designation	Purpose	Comment	Position in coordinate system
!	Connecting point	Fitting point	in origin (0,0,0)
2	Connecting point		X = 0, Y = 0, Z > 0

### Variables names

Name	Description	Attribute (optional)
L	Distance between point “!” and “2”	LAENGE

If the variables names given in the **Name** column are used, you do not need to assign any attributes to them via the Variant Editor. If different variables are required, you need to assign the attributes given in the **Attribute** column.

### VAA file

Use the Variant Editor to enter the suitable part type into the VAA file.

Then, use the Variant Editor to expand the VAA file in such a way that it contains values for the sizes specified here, and that the predefined attribute assignment is entered:

Parameter	Variable (suggestion)	Assigned attribute
All dimensions must be specified in millimetres; Exception: Nominal diameters in inches		
Nominal diameter, Connection “!” and “2”	N	NENNWEITE
Seal thickness (values same as for Variable L)	S	DICKE
<b>Additionally (only if the corresponding standard uses nominal diameters in inches):</b>		
Nominal diameter (inches), Connection “!” and “2”	NI	N_INCH
Nominal diameters in inches need to be entered as decimal values as well (e.g. 1.5 for 1 1/2”).		

If required, the attribute LAENGE (LENGTH) needs to be assigned to the length variables (see Variables names above).

For variant synchronization you also need to enter the values for the attributes which are to apply to all sub-types of the variant.

Values must be entered for at least the following attributes:

Attribute	Designation
BENENNUNG	Designation of the part
COMPONENT_TYPE	Part type (always = Semi-finished material + Plant Engineering) <u>for HELIOS database only</u>
NORMBEZEICHNUNG	Standard designation of the part (identical for all sub-types!) An entry is mandatory, even if the part corresponds to no standard.
ANSCHLUSSART	Connection type for connection "1" and "2" (Value= 20000 for Flange connection)
Possible values of the attribute ANSCHLUSSART (CONNECTION_TYPE):	
2000x	Flange connection
2100x	Flange with groove connection
2200x	Flange with notch connection
2050x	Flange connection of a seal that is exclusively intended for the pushed in end of a push-in pipe. The effect of this value is that a loose flange, together with the push-in pipe, will be connected to the seal. The pushed in of the push-in pipe must have the connection type 10xxx.Flange connection.
<p><b>Provide auxiliary part when fitting part</b> If appropriately preset in the ANSCHLUSSART (CONNECTION_TYPE) attribute for a connection, the part will provide and connect an auxiliary part of the standard specified in the attribute for the connection when being fitted. For example, if the part has a flange connection and the corresponding counter-flange is required, the content of the ANSCHLUSSART (CONNECTION_TYPE) attribute could look as follows: <b>20002 1 5100010 EN 1092-1/11/A/PN 40</b> <b>EN 1092-1/11/A/PN 40</b> is the standard designation with which the flange is to be entered into the database.</p> <p>The last character (x) provides information about the meaning of the supplement:  <b>0</b>=No supplement  <b>2</b>= The supplement consists of connection number, part type, ID, and standard of the part to be connected                      The prefixed connection number indicates the connection with which the auxiliary part is to be attached to the current connection.</p>	
 Please also read the information given in the paragraphs Connection type ID with priority information and Connection type ID - List of part standards.	

### Pressure ranges

In previous versions the nominal pressure was of no significance for the search of matching sealing gaskets. To take pressures ranges into account, the attribute **DRUCK\_MIN** (Minimum pressure) is now available.

When you now search a sealing gasket for a flange, the following, additional search condition will be generated from the nominal pressure **PN** of the flange:

**(MIN\_DRUCK ist unbelegt oder MIN\_DRUCK <= PN) und (DRUCK ist unbelegt oder DRUCK >= PN)**  
 (Minimum pressure not specified or Minimum pressure <=PN) and (Minimum pressure not specified or Minimum pressure >=PN)

Sealing gaskets without pressure specifications will thus be handled as if they were suitable for any nominal pressure.

The standard parts that are by default supplied with HiCAD do not include sealing gaskets with a defined pressure range. Therefore, this new feature is currently only relevant for gaskets that have been created by the user. Accordingly, the attribute **DRUCK\_MIN** (Min. pressure) will not be available in the search masks that are by default supplied with HELIOS. If desired, you can add this attribute with the HELIOS Mask Editor.

If you prepare the database for Plant Engineering by clicking the corresponding button in DBPlantDataImport.exe, the attribute **DRUCK\_MIN** will be entered, with the designation **Minimum pressure**, into the database.

### An example from practice:

If you do not want gaskets with an own article number for each pressure level to be created, you can avoid this by means of the **DRUCK\_MIN** attribute.

Furthermore, you have now the option to narrow search results for sealing gaskets by specifying a value for the attribute **DRUCK** (Pressure), e.g. by including only gaskets with a defined pressure in your pipe class.



#### Handling of nominal diameters in inches in the HELIOS database:

During part data synchronization, nominal diameters in inches will be taken over to the attributes N\_INCH, N2\_INCH and N3\_. The usual character strings for indication of the diameter in inches (e.g. 1 1/2" instead of 1.5) will be auto-generated in the database for the attributes NPS\_INCH, NPS2\_INCH und NPS3\_INCH.

## Variant for Part Type: Fastener

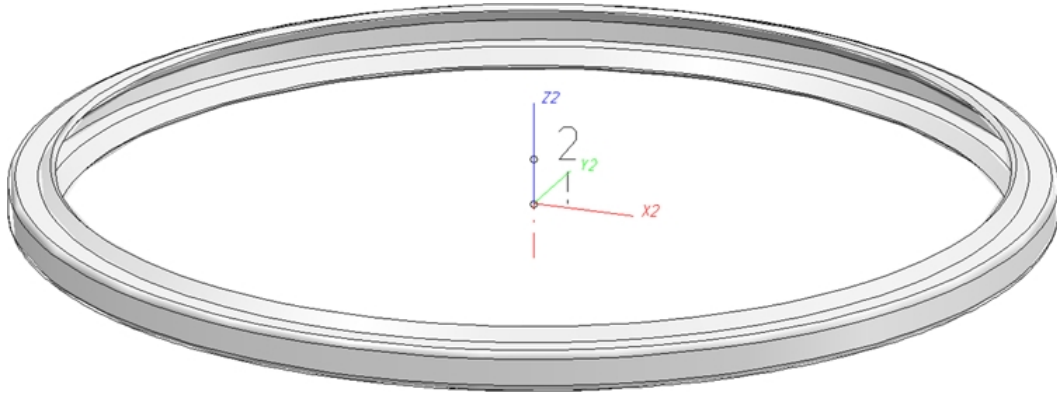

### Named isolated points

Designation	Purpose	Comment	Position in coordinate system
1	Connecting point	Fitting point	In origin (0,0,0)
2	Auxiliary point		X = 0, Y = 0, Z > 0

The part has no insertion length. When the part is inserted, it will be placed with its fitting point onto a connection of the target part. Connecting point 2 will only be used for a correct alignment.

### VAA file

Use the Variant Editor to enter the suitable part type into the VAA file.

Then, use the Variant Editor to expand the VAA file in such a way that it contains values for the sizes specified here, and that the predefined attribute assignment is entered:

Parameter	Variable (suggestion)	Assigned attribute
All dimensions must be specified in millimetres; Exception: Nominal diameters in inches		
Nominal diameter for which the fastener is intended	N	NENNWEITE
<b>Additionally (only if the corresponding standard uses nominal diameters in inches):</b>		
Nominal diameter in inches (as decimal number) for which the fastener is intended	NI	N_INCH
Nominal diameter in inches needs to be entered as a decimal number as well (e.g. 1.5 for 1 1/2").		
<b>These additional values make sense if the above attributes should not be sufficient as search criteria:</b>		
Outer diameter for which the fastener is intended	D	D_AUSSEN
Wall thickness for which the fasteners is intended	S	WANDDICKE

For variant synchronization you also need to enter the values for the attributes which are to apply to all sub-types of the variant.

Values must be entered for at least the following attributes:

Attribute	Designation
BENENNUNG	Designation of the part
COMPONENT_TYPE	Part type (always= Semi-finished product+Plant Engineering) <u>only if HELIOS database is used</u>
NORMBEZEICHNUNG	Standard designation of the part (identical for all sub-types!) An entry will even be required if the part corresponds to no standard.
ANSCHLUSSART	Connection type for which the fastener is intended
Possible values of the attribute ANSCHLUSSART (CONNECTION_TYPE):	
1000x	Butt-welded
2000x	Flange connection
2100x	Flange with groove connection
2200x	Flange with notch connection
2040x	Flange connection of a part that is not a flange itself. The part has a loose flange that is modelled as a sub-part and has no own article master attached to this connection.
3100x	Screwed, nipple
3200x	Screwed, socket
4100x	Plugged, nipple
4200x	Plugged, sleeve
5100x	Sleeve-welded, nipple
5200x	Sleeve-welded, sleeve
<p><b>Please note:</b> The option to specify, via the attribute ANSCHLUSSART, a connected part that will automatically be inserted together with the part (if the corresponding option has been set) is not available here.</p>	
<p> Please also read the information given in the paragraphs Connection type ID with priority information and Connection type ID - List of part standards.</p>	

 **Handling of nominal diameters in inches in the HELIOS database:**

During part data synchronization, nominal diameters in inches will be taken over to the attributes N\_INCH, N2\_INCH and N3\_. The usual character strings for indication of the diameter in inches (e.g. 1 1/2" instead of 1.5) will be auto-generated in the database for the attributes NPS\_INCH, NPS2\_INCH und NPS3\_INCH.

### Variant for Part Type: Saddle Connection / Elbolet

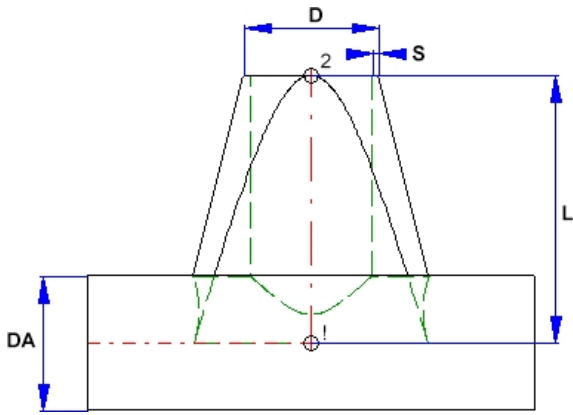

Saddle connection (Example)

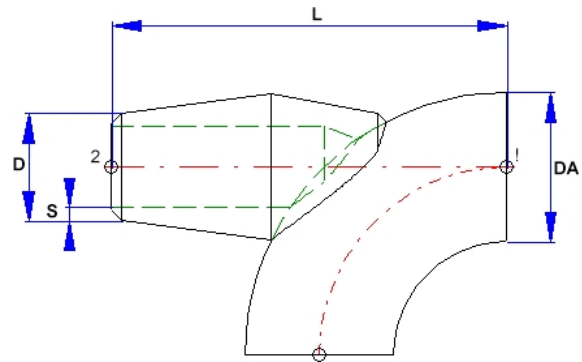

Elbolet (Example)

D=Outer diameter of the nozzle, DA=Outer diameter of the part to which the connection is made, L=Length, S=Wall thickness

Please note that the variable DA (Outer diameter) will be modified upon insertion. It will be applied to the outer diameter of the pipe to which the connection is made. This allows the calculation of the part geometry to match the respective fitting situation. Please check whether the geometry of the constructed saddle connection correctly adjust itself to a modified DA value.

#### Position of connecting points and determination of insertion lengths for various connection types

Connection for butt welding	Flange connection	Connecting nipple for screwed, plugged or socket-welded connection	Connecting socket for screwed, plugged or socket-welded connection
a = Insertion length dimension (e.g. L, L1 etc.)	a = Insertion length dimension (e.g. L, L1 etc.)	a = Insertion length dimension (e.g. L, L1 etc.)	a = Insertion length dimension (e.g. L, L1 etc.)

#### Named isolated points

Designation	Purpose	Comment	Position in coordinate system
!	Connecting point	Fitting point	in origin (0,0,0)
2	Connecting point		X = 0, Y = 0, Z > 0

**Variables names**

Name	Designation	Attribute (optional)
L	Distance between point "1" and "2"	LAENGE

If the variables names given in the **Name** column are used, you do not need to assign any attributes to them via the Variant Editor. If different variables are required, you need to assign the attributes given in the **Attribute** column.

**VAA file**

Use the Variant Editor to enter the suitable part type into the VAA file.

Then, use the Variant Editor to expand the VAA file in such a way that it contains values for the sizes specified here, and that the predefined attribute assignment is entered:

Parameter	Variable (suggestion)	Assigned attribute
All dimensions must be specified in millimetres; Exception: Nominal diameters in inches		
Nominal diameter, Connection "1" and "2"	N	NENNWEITE
Length	L	LAENGE
<b>Additionally (only if the corresponding standard uses nominal diameters in inches):</b>		
Nominal diameter (inches), Connection "1" and "2"	NI	N_INCH
As only decimal values are saved to the VAA file as parameter values, nominal diameters in inches need to be entered as decimal values as well (e.g. 1.5 for 1 1/2").		
<b>These parameters are to be considered for all connection types except for flange connections. For connecting sockets they refer to the pipe to be inserted:</b>		
Outer diameter of the part to which the connection is made. This allows a suitable adjustment of the nozzle.	DA	D_AUSSEN
Outer diameter, Connection "1" and "2"	D	D2_AUSSEN
Wall diameter, Connection "1" and "2"	S	WANDDICKE

If required, the attribute LAENGE needs to be assigned to the length variables (see Variables names above).

For variant synchronization you also need to enter the values for the attributes which are to apply to all sub-types of the variant.

Values must be entered for at least the following attributes:

Attribute	Description
BENENNUNG	Designation of part
COMPONENT_TYPE	Part type (always = Semi-finished material + Plant Engineering) <u>for HELIOS database only</u>
NORMBEZEICHNUNG	Standard designation of the part. An entry is mandatory, even if the part corresponds to no standard.
ANSCHLUSSART	Connection type for Connection "1"(and "2") If the same connection type is required at both part ends it will suffice to assign a

Attribute	Description																								
ANSCHLUSSART2	value to the attribute ANSCHLUSSART.  If different connection types are required at the part ends you need to assign the value of the connection type for Connection 1 to the attribute ANSCHLUSSART, and the connection type for Connection 2 to the attribute ANSCHLUSSART2.																								
<p>Possible values of the attributes ANSCHLUSSART (CONNECTION_TYPE) and ANSCHLUSSART2 (CONNECTION_TYPE2):</p> <table border="0"> <tr> <td style="vertical-align: top;"> <table border="0"> <tr><td>1000x</td><td>Butt-welded</td></tr> <tr><td>2000x</td><td>Flange connection</td></tr> <tr><td>2100x</td><td>Flange with groove connection</td></tr> <tr><td>2200x</td><td>Flange with notch connection</td></tr> <tr><td>2040x</td><td>Flange connection of a part that is not a flange itself. The part has a loose flange that is modelled as a sub-part and has no own article master attached to this connection</td></tr> <tr><td>3100x</td><td>Screwed, nipple</td></tr> <tr><td>3200x</td><td>Screwed, socket</td></tr> <tr><td>4100x</td><td>Plugged, nipple</td></tr> <tr><td>4200x</td><td>Plugged, socket</td></tr> <tr><td>5100x</td><td>Socket-welded, nipple</td></tr> <tr><td>5200x</td><td>Socket-welded, socket</td></tr> </table> </td> <td style="vertical-align: top; padding-left: 20px;"> <p><b>Provide auxiliary part when fitting part</b></p> <p>If appropriately preset in the ANSCHLUSSART (CONNECTION_TYPE) attribute for a connection, the part will provide and connect an auxiliary part of the standard specified in the attribute for the connection when being fitted. For example, if the part has a flange connection and the corresponding counter-flange is required, the content of the ANSCHLUSSART (CONNECTION_TYPE) attribute could look as follows:  <b>20002 1 5100010 EN 1092-1/11/A/PN 40</b>  <b>EN 1092-1/11/A/PN 40</b> is the standard designation with which the flange is to be entered into the database.</p> </td> </tr> </table> <p>The last character (x) provides information about the meaning of the supplement:  <b>0</b> = No supplement  <b>2</b> = The supplement consists of connection number, part type, ID, and standard of the part to be connected                      The prefixed connection number indicates the connection with which the auxiliary part is to be attached to the current connection.</p> <p> Please also read the information given in the paragraphs Connection type ID with priority information and Connection type ID - List of part standards.</p>		<table border="0"> <tr><td>1000x</td><td>Butt-welded</td></tr> <tr><td>2000x</td><td>Flange connection</td></tr> <tr><td>2100x</td><td>Flange with groove connection</td></tr> <tr><td>2200x</td><td>Flange with notch connection</td></tr> <tr><td>2040x</td><td>Flange connection of a part that is not a flange itself. The part has a loose flange that is modelled as a sub-part and has no own article master attached to this connection</td></tr> <tr><td>3100x</td><td>Screwed, nipple</td></tr> <tr><td>3200x</td><td>Screwed, socket</td></tr> <tr><td>4100x</td><td>Plugged, nipple</td></tr> <tr><td>4200x</td><td>Plugged, socket</td></tr> <tr><td>5100x</td><td>Socket-welded, nipple</td></tr> <tr><td>5200x</td><td>Socket-welded, socket</td></tr> </table>	1000x	Butt-welded	2000x	Flange connection	2100x	Flange with groove connection	2200x	Flange with notch connection	2040x	Flange connection of a part that is not a flange itself. The part has a loose flange that is modelled as a sub-part and has no own article master attached to this connection	3100x	Screwed, nipple	3200x	Screwed, socket	4100x	Plugged, nipple	4200x	Plugged, socket	5100x	Socket-welded, nipple	5200x	Socket-welded, socket	<p><b>Provide auxiliary part when fitting part</b></p> <p>If appropriately preset in the ANSCHLUSSART (CONNECTION_TYPE) attribute for a connection, the part will provide and connect an auxiliary part of the standard specified in the attribute for the connection when being fitted. For example, if the part has a flange connection and the corresponding counter-flange is required, the content of the ANSCHLUSSART (CONNECTION_TYPE) attribute could look as follows:  <b>20002 1 5100010 EN 1092-1/11/A/PN 40</b>  <b>EN 1092-1/11/A/PN 40</b> is the standard designation with which the flange is to be entered into the database.</p>
<table border="0"> <tr><td>1000x</td><td>Butt-welded</td></tr> <tr><td>2000x</td><td>Flange connection</td></tr> <tr><td>2100x</td><td>Flange with groove connection</td></tr> <tr><td>2200x</td><td>Flange with notch connection</td></tr> <tr><td>2040x</td><td>Flange connection of a part that is not a flange itself. The part has a loose flange that is modelled as a sub-part and has no own article master attached to this connection</td></tr> <tr><td>3100x</td><td>Screwed, nipple</td></tr> <tr><td>3200x</td><td>Screwed, socket</td></tr> <tr><td>4100x</td><td>Plugged, nipple</td></tr> <tr><td>4200x</td><td>Plugged, socket</td></tr> <tr><td>5100x</td><td>Socket-welded, nipple</td></tr> <tr><td>5200x</td><td>Socket-welded, socket</td></tr> </table>	1000x	Butt-welded	2000x	Flange connection	2100x	Flange with groove connection	2200x	Flange with notch connection	2040x	Flange connection of a part that is not a flange itself. The part has a loose flange that is modelled as a sub-part and has no own article master attached to this connection	3100x	Screwed, nipple	3200x	Screwed, socket	4100x	Plugged, nipple	4200x	Plugged, socket	5100x	Socket-welded, nipple	5200x	Socket-welded, socket	<p><b>Provide auxiliary part when fitting part</b></p> <p>If appropriately preset in the ANSCHLUSSART (CONNECTION_TYPE) attribute for a connection, the part will provide and connect an auxiliary part of the standard specified in the attribute for the connection when being fitted. For example, if the part has a flange connection and the corresponding counter-flange is required, the content of the ANSCHLUSSART (CONNECTION_TYPE) attribute could look as follows:  <b>20002 1 5100010 EN 1092-1/11/A/PN 40</b>  <b>EN 1092-1/11/A/PN 40</b> is the standard designation with which the flange is to be entered into the database.</p>		
1000x	Butt-welded																								
2000x	Flange connection																								
2100x	Flange with groove connection																								
2200x	Flange with notch connection																								
2040x	Flange connection of a part that is not a flange itself. The part has a loose flange that is modelled as a sub-part and has no own article master attached to this connection																								
3100x	Screwed, nipple																								
3200x	Screwed, socket																								
4100x	Plugged, nipple																								
4200x	Plugged, socket																								
5100x	Socket-welded, nipple																								
5200x	Socket-welded, socket																								

 **Important:**

- When working with the **HELiOS database**, please pay attention to the correct classification matching the part type.
- During variant synchronization the **Nominal diameters in inches** will initially only be taken over into the attribute N\_INCH in the form of decimal numbers. The usual character strings for the specification of the nominal diameter in inches (e.g. 1 1/2" instead of 1.5) can be subsequently generated in the HELiOS database for the attribute NPS\_INCH. For this purpose the HiCAD macro ANLDB\_ZOLLATTRIGEN.MAC in the \HICAD\MAKROANL folder is used.



## Rules for the Creation of Symbolic Representations

Symbolic representations are required for parts or part variants that are used for pipelines of which you want to generate isometries. You use the **Symbol Editor** to draw such symbolic representations.

Below please find the example of a T-piece:

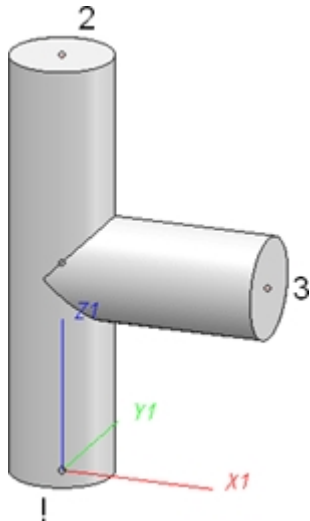

3-D part

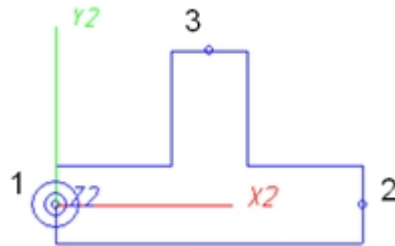

Symbolic representation

### 1. Position in the coordinate system

The symbolic representation is drawn in the **Symbol Editor**  as a 2-D part in the XY-plane. The Z-axis in the 3-D part corresponds to the X-axis in the symbolic 2-D representation. The 3-D X-axis corresponds to the 2-D Y-axis.

### 2. Named isolated points:

The symbolic representation needs to contain (just as the 3-D part) named isolated points indicating the positions of connections or auxiliary points. The point "1" in the symbolic representation is located in the origin of the coordinate system and corresponds to the point "1" in the 3-D part. Points "2" and "3" correspond to the same-named points in the 3-D part.

There are only two parts that require a point "4" in their symbolic representations, namely **Branch** and **Y-piece** (the 4-way valve contains no point "4").

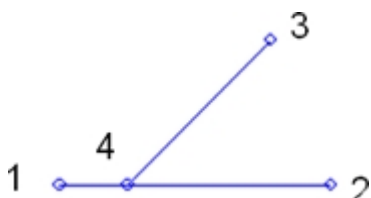

Example: Branch

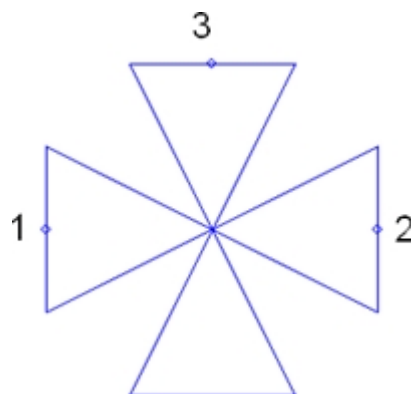

Example: 4-way valve



**Rechtliche Hinweise:**

© 2019 ISD © Software und Systeme GmbH alle Rechte vorbehalten

Dieses Handbuch sowie die darin beschriebene Software werden unter Lizenz zur Verfügung gestellt und dürfen nur in Übereinstimmung mit den Lizenzbedingungen verwendet oder kopiert werden. Der Inhalt dieses Handbuches dient ausschließlich zur Information, kann ohne Vorankündigung verändert werden und ist nicht als Verpflichtung von ISD Software und Systeme GmbH anzusehen. Die ISD Software und Systeme GmbH gibt keine Gewähr oder Garantie hinsichtlich der Richtigkeit oder Genauigkeit der Angaben in dieser Dokumentation. Kein Teil dieser Dokumentation darf, außer durch das Lizenzabkommen ausdrücklich erlaubt, ohne vorherige, schriftliche Genehmigung von ISD Software und Systeme GmbH reproduziert, in Datenbanken gespeichert oder in irgendeiner Form übertragen werden.

Alle erwähnten Produkte sind Warenzeichen oder eingetragene Warenzeichen ihrer jeweiligen Hersteller.

**Legal notes**

© 2019 ISD © Software und Systeme GmbH. All rights reserved.

This User Guide and the software described herein are provided in conjunction with a license and may only be used or copied in accordance with the terms of the license. The contents of this User Guide solely serve the purpose of information; it may be modified without prior notice and may not be regarded as binding for the ISD Software und Systeme GmbH. The ISD Software und Systeme GmbH does not assume any responsibility for the correctness or accuracy of the information provided in this document. No part of this document may be reproduced, saved to databases or transferred in any other form without prior written permission by the ISD Software und Systeme GmbH, unless expressly allowed by virtue of the license agreement.

All mentioned products are trademarks or registered trademarks of their respective manufacturers and producers.



**ISD Software und Systeme GmbH**

Hauert 4  
44227 Dortmund  
Germany  
Tel. +49 (0)231 9793-0  
Fax +49 (0)231 9793-101  
info@isdgroup.de

**ISD Berlin**

Paradiesstraße 208a  
12526 Berlin  
Germany  
Tel. +49 (0)30 634178-0  
Fax +49 (0)30 634178-10  
berlin@isdgroup.de

**ISD Austria GmbH**

Hafenstraße 47-51  
4020 Linz  
Austria  
Tel. +43 (0)732 21 04 22-0  
Fax +43 (0)732 21 04 22-29  
info@isdgroup.at

**ISD Hamburg**

Strawinskystraße 2  
25337 Elmshorn  
Germany  
Tel. +49 (0)4121 740980  
Fax +49 (0)4121 4613261  
hamburg@isdgroup.de

**ISD Benelux b.v.**

Het Zuiderkruis 33  
5215 MV 's-Hertogenbosch  
The Netherlands  
Tel. +31 (0)73 6153-888  
Fax +31 (0)73 6153-899  
info@isdgroup.nl

**ISD Hannover**

Hamburger Allee 24  
30161 Hanover  
Germany  
Tel. +49 (0)511 616803-40  
Fax +49 (0)511 616803-41  
hannover@isdgroup.de

**ISD Benelux b.v.**

Grote Voort 293A  
8041 BL Zwolle  
The Netherlands  
Tel. +31 (0)73 6153-888  
Fax +31 (0)73 6153-899  
info@isdgroup.nl

**ISD Nürnberg**

Nordostpark 7  
90411 Nuremberg  
Germany  
Tel. +49 (0)911 95173-0  
Fax +49 (0)911 95173-10  
nuernberg@isdgroup.de

**ISD Schweiz AG**

Rosenweg 2  
4500 Solothurn  
Switzerland  
Tel. +41 (0)32 624 13-40  
Fax +41 (0)32 624 13-42  
info@isdgroup.ch

**ISD Ulm**

Wilhelmstraße 25  
89073 Ulm  
Germany  
Tel. +49 (0)731 96855-0  
Fax +49 (0)731 96855-10  
ulm@isdgroup.de

[www.isdgroup.com](http://www.isdgroup.com)